

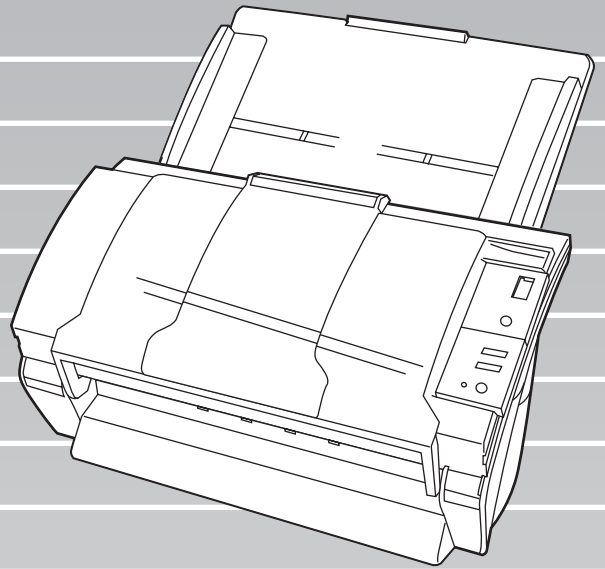

P3PC-1922-01ENZO

fi-5530C2 Image Scanner ***Operator's Guide***



CONTENTS

■ Regulatory Information	vii
■ Note of Liability	ix
■ Safety Precautions	xii
Chapter 1 BASIC SCANNER OPERATIONS.....	1
1.1 Turning the Scanner ON	2
1.2 Placing Documents on the ADF	6
1.3 Scanning Documents	10
1.4 How to Use Scanner Drivers.....	12
1.5 How to Use ScandAll PRO	29
Chapter 2 SCANNING VARIOUS TYPES OF DOCUMENTS	45
2.1 Scanning Double-Sided Documents.....	46
2.2 Scanning Documents of Different Widths.....	47
2.3 Scanning Thin Documents	48
2.4 Scanning Documents Longer Than A3 Size	49
2.5 Saving Scanned Images in PDF Format.....	51
2.6 Excluding a Color from Images (Dropout Color).....	62
2.7 Skipping Blank Pages	64
2.8 Detecting Multifeeds.....	66

2.9	Correcting Skew	71
2.10	To Output Multi-Images.....	74
2.11	Color/Monochrome Auto Detection	77
2.12	Splitting a Page in Two Pages	79
2.13	Removing Punch Holes from Images	81
2.14	Scanning by Pressing the Scan Button on the Scanner	84
Chapter 3	DAILY CARE	87
3.1	Cleaning Materials and Locations requiring Cleaning..	88
3.2	Cleaning the ADF.....	90
Chapter 4	REPLACING CONSUMABLES	95
4.1	Consumable and Replacement Cycle.....	96
4.2	Replacing the Pad ASSY.....	99
4.3	Replacing the Pick Roller.....	102
Chapter 5	TROUBLESHOOTING	109
5.1	Removing Jammed Documents	110
5.2	Error Indications in the Function Number Display.....	112
5.3	Remedying Common Troubles.....	114
5.4	Items to check before contacting the agent where you bought the scanner	127
5.5	Checking Labels on the Scanner	130

Chapter 6	DOCUMENT SPECIFICATIONS FOR ADF	131
6.1	Document Size	132
6.2	Document Quality	133
6.3	Maximum ADF Capacity	137
6.4	Area Not To Be Perforated.....	138
6.5	Specifying How to Detect Multifeed.....	139
Chapter 7	SCANNER SPECIFICATIONS	141
7.1	Basic Specifications.....	142
7.2	Installation Specifications	144
7.3	External Dimensions	145
APPENDIX A	Using the [Scan] or [Send to] Button	AP-1
APPENDIX B	GLOSSARY OF TERMS.....	AP-4
INDEX	IN-1

INTRODUCTION

Thank you for purchasing the fi-5530C2 Duplex Color Scanner. This document describes how to handle the fi-5530C2 and basic operations. Before you start using the fi-5530C2, be sure to read this manual thoroughly to ensure correct use.

■Regulatory Information

FCC declaration

This equipment has been tested and found to comply with the limits for a Class B digital device, pursuant to Part 15 of the FCC Rules. These limits are designed to provide reasonable protection against harmful interference in a residential installation. This equipment generates, uses, and can radiate radio frequency energy and, if not installed and used in accordance with the instruction manual, may cause harmful interference to radio communications. However, there is no guarantee that interference will not occur in a particular installation. If this equipment does cause harmful interference to radio or television reception, which can be determined by turning the equipment off and on, the user is encouraged to try to correct the interference by one or more of the following measures:

- Reorient or relocate the receiving antenna.
- Increase the separation between the equipment and receiver.
- Connect the equipment into an outlet on a circuit different from that to which the receiver is located.
- Consult your dealer or an experienced radio/TV technician.

FCC warning: Changes or modifications not expressly approved by the party responsible for compliance could void the user's authority to operate the equipment.

NOTICE	The use of a shielded interface cable is required to comply with the Class B limits of Part 15 of FCC rules. The length of the AC cable must be 3 meters (10 feet) or less.
--------	--

Canadian DOC Regulations

This digital apparatus does not exceed the Class B limit for radio noise emissions from digital apparatus set out in the Radio interference Regulations of the Canadian Department of Communications.

This Class B digital apparatus complies with Canadian ICES-003.

Le présent appareil numérique n'émet pas de parasites radioélectriques dépassant les limites applicables aux appareils numériques de la classe B et prescrites dans le Règlement sur le brouillage radioélectrique dictées par le Ministère des Communications du Canada.

Cet appareil numérique de la classe B est conforme à la norme NMB-003 du Canada.

Bescheinigung des Herstellers / Importeurs

Für den fi-5530C2 wird folgendes bescheinigt:

- In Übereinstimmung mit den Bestimmungen der EN45014(CE) funktentstört
- Maschinenlärminformationsverordnung 3.GPSGV: Der höchste Schalldruckpegel beträgt 70 dB (A) oder weniger, gemäß EN ISO 7779.

International ENERGY STAR® Program

As an ENERGY STAR® Partner, PFU LIMITED has determined that this product meets the ENERGY STAR® guidelines for energy efficiency.

The International ENERGY STAR® Office Equipment Program is an international program that promotes energy saving through the penetration of energy efficient computers and other office equipment. The program backs the development and dissemination of products with functions that effectively reduce energy consumption. It is an open system in which business proprietors can participate voluntarily. The targeted products are office equipment such as computers, monitors, printers, facsimiles, copiers, scanners, and multifunction devices. Their standards and logos are uniform among participating nations.



■ Note of Liability

READ ALL OF THIS MANUAL CAREFULLY BEFORE USING THIS PRODUCT. IF THIS PRODUCT IS NOT USED CORRECTLY, UNEXPECTED INJURY MAY BE CAUSED TO USERS OR BYSTANDERS.

Also, keep this manual in a safe place so that it can be easily referred to during use of this product.

While all efforts have been made to ensure the accuracy of all information in this manual, PFU assumes no liability to any party for any damage caused by errors or omissions or by statements of any kind in this manual, its updates or supplements, whether such errors are omissions or statements resulting from negligence, accidents, or any other cause. PFU further assumes no liability arising from the application or use of any product or system described herein; nor any liability for incidental or consequential damages arising from the use of this manual. PFU disclaims all warranties regarding the information contained herein, whether expressed, implied, or statutory.

Use in High-safety Applications

This product has been designed and manufactured on the assumption that it will be used in office, personal, domestic, regular industrial, and general-purpose applications. It has not been designed and manufactured for use in applications (simply called "high-safety applications" from here on) that directly involve danger to life and health when a high degree of safety is required, for example, in the control of nuclear reactions at nuclear power facilities, automatic flight control of aircraft, air traffic control, operation control in mass-transport systems, medical equipment for sustaining life, and missile firing control in weapons systems, and when provisionally the safety in question is not ensured. The user should use this product with adopting measures for ensuring safety in such high-safety applications. PFU LIMITED assumes no liability whatsoever for damages arising from use of this product by the user in high-safety applications, and for any claims or compensation for damages by the user or a third party.

About the Use of Mercury

	Lamp(s) inside this product contain mercury and must be recycled or disposed of according to local, state, or federal laws.
---	---

To avoid unexpected injuries;

- Do not put the substance contained in the lamp in your mouth as it has mercury.
- Do not breathe the chemical liquid contained in the scanner lamps.
- Do not incinerate, crush, or shred the lamps or scanner parts.

Trademarks

Microsoft, Windows, and Windows NT are registered trademarks of Microsoft Corporation in the United States and/or other countries.

ISIS and QuickScan are trademarks or registered trademarks of EMC Corporation in the United States. Adobe, the Adobe logo, and Acrobat are either registered trademarks of Adobe Systems Incorporated in the United States and/or other countries.

Other product names are the trademarks or registered trademarks of the respective companies.

How Trademarks Are Indicated in This Manual

Operating systems (OS) are indicated as follows:

Windows 2000:	Microsoft® Windows® 2000 Professional operating system
Windows XP:	Microsoft® Windows® XP Professional operating system (32/64-bit) Microsoft® Windows® XP Home Edition operating system
Windows Server 2003:	Microsoft® Windows® Server™ 2003 Standard Edition operating system (32/64-bit)
Windows Vista:	Microsoft® Windows Vista™ Home Basic operating system (32/64-bit) Microsoft® Windows Vista™ Home Premium operating system (32/64-bit) Microsoft® Windows Vista™ Business operating system (32/64-bit) Microsoft® Windows Vista™ Enterprise operating system (32/64-bit) Microsoft® Windows Vista™ Ultimate operating system. (32/64-bit)

Where there is no distinction between the different versions of the above operating system, the general term "Windows" is used.

Adobe Acrobat: Adobe® Acrobat®

All the descriptions in this manual assume the usage of Adobe Acrobat bundled with this product. However, Adobe Acrobat may be upgraded without notice. If the descriptions differ from the screens actually displayed, refer to the Acrobat's "Help".

Manufacturer

PFU LIMITED

International Sales Dept., Imaging Business Division, Products Group
Solid Square East Tower, 580 Horikawa-cho, Saiwai-ku, Kawasaki-shi Kanagawa 212-8563, Japan
Phone : (81-44) 540-4538

All Rights Reserved, Copyright© PFU LIMITED 2007

About Maintenance

The user must not perform repairs on this scanner.
Contact the store where you purchased the scanner or an authorized FUJITSU Image Scanner service provider to make repairs to this product.

Warning Indications Used in This Manual



This indication alerts operators to an operation that, if not strictly observed, may result in severe injury or death.

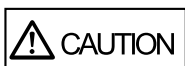

This indication alerts operators to an operation that, if not strictly observed, may result in safety hazards to personnel or damage to equipment.

■ Safety Precautions



Do not damage the AC cable.



A damaged AC cable may cause fire or electric shock. Do not place heavy objects on AC cables, or pull, bend, twist, heat, damage or modify AC cables.
Do not use damaged AC cables or power plugs, or install any cables or power plugs to loose wall sockets.

Use only specified AC cables and connector cables



Use only specified AC cables and connector cables. Failure to use the correct cables might cause electric shock and/or equipment failure.
Please don't use the AC cable provided with this scanner for other devices, since this might cause equipment failure and other troubles or an electric shock.

Use this scanner only at the indicated power voltage. Do not connect to multiple-power strips.



Use this scanner only at the indicated power voltage and current. Improper power voltage and current might cause fire or electric shock. Do not connect to multiple-power strips.

Do not touch the AC cable with wet hands.



Do not touch the power plug with wet hands. Doing so might cause electric shock.

Wipe any dust from the power plug.



Wipe off any dust from metal parts on the power plug or metal fittings with a soft, dry cloth. Accumulated dust might cause fire or electric shock.

Do not install the device in locations that has oil smoke, steam, humidity, and dust.



Do not install the scanner in locations subject to oil smoke, steam, humidity, and dust. Doing so might cause a fire or electric shock.

Turn the scanner OFF if it is damaged.



If the scanner is damaged for any reason, disconnect immediately the power plug in order to turn out the scanner. Contact the store where you purchased the scanner.

Do not put liquids inside the scanner.



Do not insert or drop metal objects in to the scanner. Do not scan wet documents or documents with paper clips or staples. Do not splash or allow the scanner to get wet.



If foreign objects (water, small metal objects, liquids, etc.) get inside the scanner, immediately turn off the scanner and disconnect the power plug from the power outlet, then contact the store where you bought the scanner or the Maintenance Service Center. Pay particular attention to this warning in households where there are small children.



Do not touch the inside of the scanner unless necessary.



Do not take apart or modify the scanner. The inside of the scanner contains high-voltage components. Touching these components might cause fire or electric shock.

Do not use the scanner if there is a strange odor.



If you detect excessive heat coming from the device or detect other problems such as smoke, strange smells or noises, disconnect immediately the power plug in order to turn out the scanner. Make sure that any smoke coming from it has stopped, before contacting the store where you bought the scanner or an authorized FUJITSU scanner service provider.



Do not install the scanner on unstable surfaces.



Make sure that the scanner is installed on a flat, level surface and that none of its parts extend beyond the surface top, such as a desk or table. Do not install the scanner on unstable surfaces. Install the scanner on a level surface that is free of vibration to prevent it from falling.



Install the scanner on a strong surface that will support the weight of the scanner and other devices.

Do not block the ventilation ports.



Do not block the ventilation ports. Blocking the ventilation ports generates heat inside of scanner, which may result in fire or scanner failure.

Do not place heavy objects or stand on top of the scanner.



Do not place heavy objects on the scanner or use the scanner's surface top to perform other work. Improper installation might cause injuries and equipment failure.

Firmly insert the power plug.



Firmly insert the power plug as far it can go into the power outlet.

Avoid any contact when scanner is in use.



Avoid touching any scanner mechanism during scanning since this may cause injuries.

Do not use the scanner immediately after moving it from a cold place into a warm room.



Do not use the device immediately after moving it from a cold place into a warm room. This may cause condensation, which might lead to scanning errors. Let the device dry about one or two hours before you use it.

Before moving the scanner, disconnect the power plug from the power outlet.



Do not move the scanner with the power and interface cables connected as this might damage the cables, causing fire, electric shock or injuries. Before moving the scanner, be sure to disconnect the power plug from the power outlet, and all other data cables. Make sure that the floor is free of any obstruction.

Protect the scanner from static electricity.



Install the scanner away from strong magnetic fields and other sources of electronic noise. Also, protect the scanner from any static electricity as this might cause the scanner to malfunction.

Do not use aerosol sprays near the scanner.



Do not use aerosol sprays to clean the scanner. Aerosol sprays cause dirt and dust to enter the scanner, resulting scanner failure and malfunction.

Disconnect the power plug from the power outlet when the scanner is not used for a long period of time.



When the scanner is not going to be used for a long period of time, be sure to disconnect the power plug from the power outlet for safety.

Do not install the scanner in the direct sunlight.



Do not install the scanner under direct sunlight or near heating apparatus. Doing so might cause excessive heat to build up inside the scanner, which can cause scanner trouble or even fire. Install the scanner in a well-ventilated location.

Chapter 1

BASIC SCANNER OPERATIONS

This chapter describes the basic operations of the scanner.

In this chapter, Windows XP screenshots are used as examples.

The screens and operations may differ slightly if the operating system (OS) you are using is not Windows XP.

In addition, when FUJITSU TWAIN 32 is updated, the screens and operations provided in this chapter may be different from the actual ones.

1.1 Turning the Scanner ON.....	2
1.2 Placing Documents on the ADF	6
1.3 Scanning Documents	10
1.4 How to Use Scanner Drivers.....	12
1.5 How to Use ScandAll PRO	29

1.1 Turning the Scanner ON

1. Press the power button on the operator panel.

The scanner is turned on, and the green LED on the operator panel illuminates.

During the initialization, the indication of the Function Number Display changes as follows:

8 ⇒ P ⇒ 0 ⇒ 1

A number "1" indicated on the operator panel shows that the scanner is in the ready status.

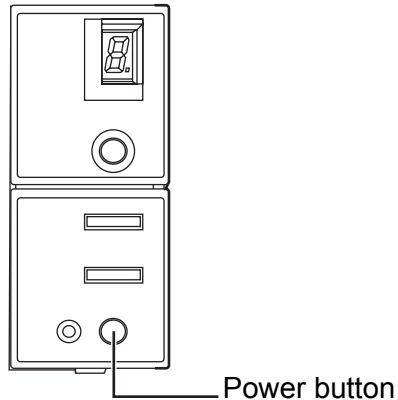

To turn the scanner off, hold the power button down for at least two seconds.

■ About Power ON/OFF Control

You can select how to power the scanner on/off; by pressing the Power button, or by connecting/disconnecting the AC cable.

The procedure is as follows:

1. Open the [Scanner Properties] dialog box.
 - 1) Turn on the scanner, and make sure that the scanner is connected to your personal computer. Refer to "2.2 Connecting the Scanner to a PC" in fi-5530C2 Getting Started contained in the CD-ROM for information about how to connect the scanner to your personal computer.
 - 2) Double click the [Printer and Other Hardware] icon in Control Panel.

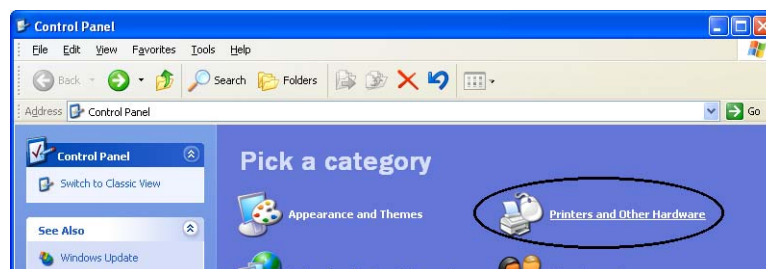

⇒ The [Printer and Other Hardware] window appears.

- 3) In the [Printers and Other Hardware] window, double click the [Scanners and Cameras] icon.

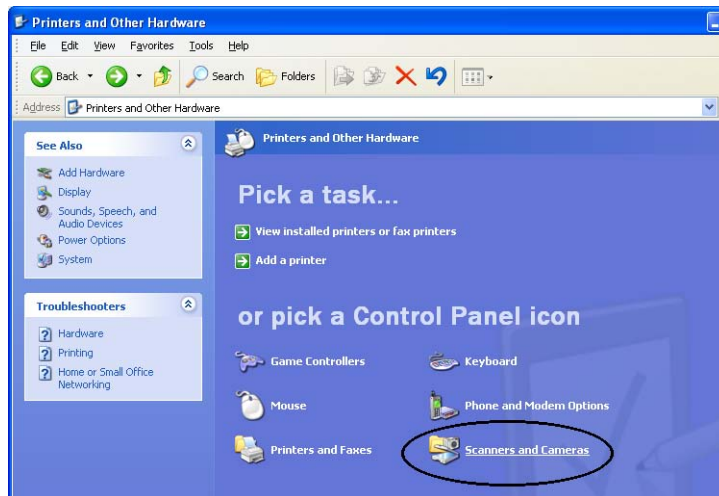

⇒ The [Scanners and Cameras] window appears.

- 4) In Windows XP and Windows Server 2003, right-click on the [fi-5530C2dj] icon, and then select [Properties]. In Windows 2000 and Windows Vista, double-click on the [fi-5530C2dj] icon.

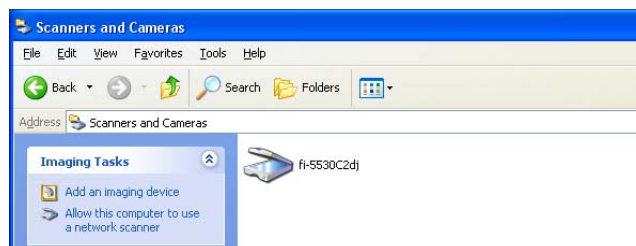

⇒ The [fi-5530C2dj Properties] dialog box appears.

- 5) Select the [Device Set] tab.

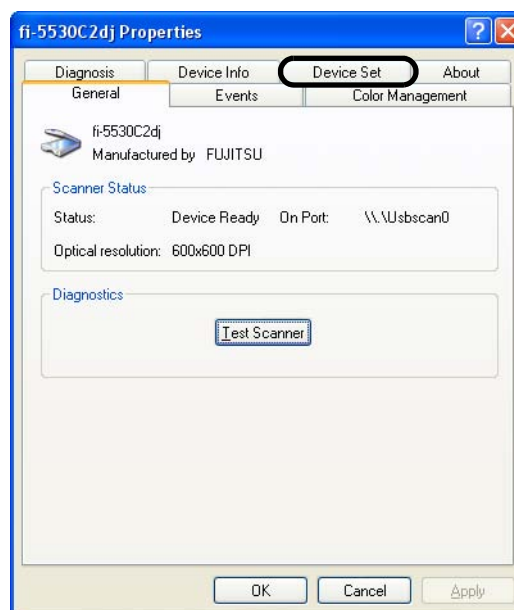

⇒ The dialog box shown below appears.

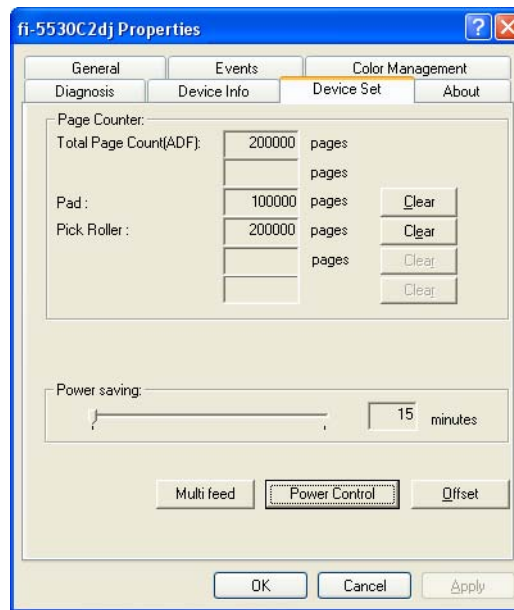

2. Click the [Power Control] button

⇒ The dialog box shown below appears.



3. In this dialog box, do the following:

- To power on/off the scanner by pressing the Power button:
⇒ Select [Enable power switch].
- To power on/off the scanner by connecting/disconnecting the AC cable:
⇒ Select [Disable power switch].

■ Power Save Mode

The Power Save mode keeps the scanner in a low-powered state if no operation is performed on the scanner for 15 minutes after it has been turned on. The scanner is automatically switched to the Power Save mode.

In the Power Save mode, the indication of the Function Number Display on the operator panel goes out, while the green LED is kept lit.

To return the scanner from the Power Save mode, perform one of the following operations:

- Place documents on the ADF paper chute.
- Press any button on the operator panel.
The scanner will be turned off when pressing down the power button for 2 seconds or longer.
- Execute a command from the scanner driver.

1.2 Placing Documents on the ADF



For details about paper sizes and paper materials for the ADF to work properly, refer to [Chapter 6 "DOCUMENT SPECIFICATIONS FOR ADF"](#) (page 131).

1. Align the edges of sheets in the document.

- 1) Confirm that all sheets have the same width.
- 2) Check the number of the sheets in the document stack.

The standard number of sheets that can be loaded on the scanner is as follows:

- A4-size paper or smaller that makes a document stack of 10 mm or less (100 sheets at 80 g/m² or at 20 lb)
- Over A4-size paper that makes a document stack of 5 mm or less (50 sheets at 80 g/m² or at 20 lb)

2. Fan the sheets as follows:

- 1) Lightly hold the both ends of the stack with both hands, and bend it as shown in the figure below.

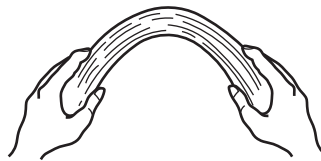

- 2) Hold the stack firmly with both hands and bend them back so that the bent section rises up in the middle of the stack as shown in the figure below.



- 3) Repeat steps 1) and 2) a couple of times.
- 4) Rotate the document 90 degrees, and fan the stack again.

3. Align the top of the sheets.

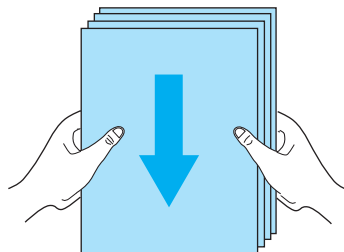

4. Place the document on the ADF paper chute.

Set the document face-down in the ADF paper chute (so that the side to be scanned faces toward the ADF paper chute).

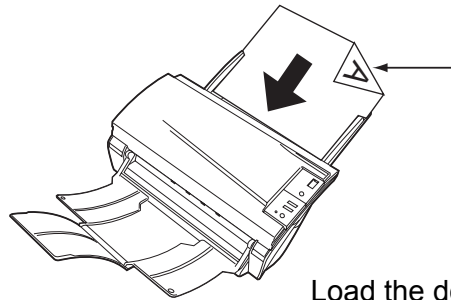

Load the documents facing the ADF paper chute.(face down)



This scanner can scan ID cards through the ADF with the following precautions.

- Place one card at a time into the ADF.
- ID card feeding requires the card to be fed through the ADF in portrait mode as in the following figure.

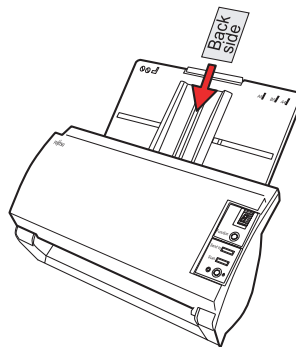

- Smooth cards should be placed face down in the ADF.

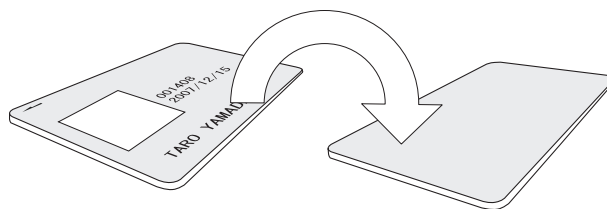

- The card to be scanned should be within the ISO7810 compliance, type ID-1.
 ISO7810-compliant, Type ID-1 card
 Material: PVC (Poly vinyl chloride) or PVCA (Polyvinyl chloride acetate)
 Dimensions: 3.4 inch (height) x 2.1 inch (width) / 86 mm x 54 mm
 Thickness: 0.03 ± 0.003inch / 0.76 ± 0.08mm
- Embossed cards (on which a raised effect is created) cannot be scanned.
- Cards that are excessively rigid or less flexible may not feed smoothly and excessive noise may occur.
- Cards should be clean from oil and without labels.
- Cards cannot be scanned when the imprinter is installed.





Before placing the document, pull out the ADF paper chute extension depending on the lengths of the document.

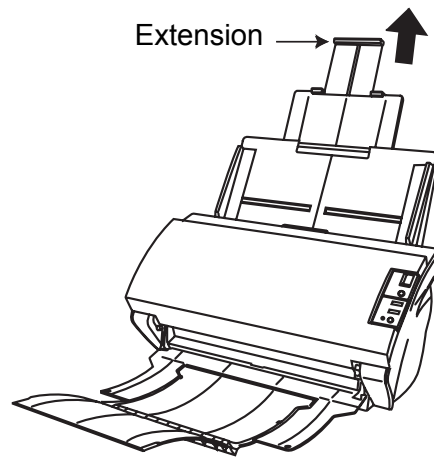

Place the document so that the height of the document will not surpass the line mark located at the side guide.

For A4-size paper or smaller, place the document so that the height of the document will not surpass the [Letter/A4/Smaller] line mark.

For paper larger than A4 size, place the document so that the height of the document will not surpass the [Over Letter/A4 Size] line mark.

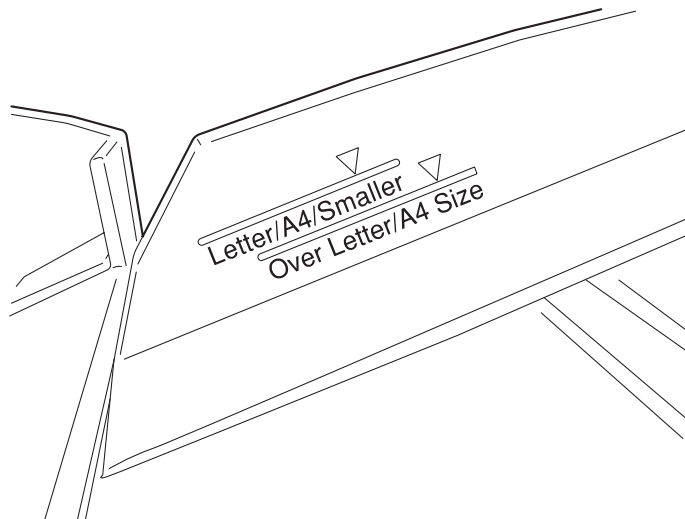

5. Adjust the side guides to the width of the document.

Move the side guides so that they touch both sides of the document.

If there is any clearance between the side guides and the edges of the document, the scanned image may be skewed.

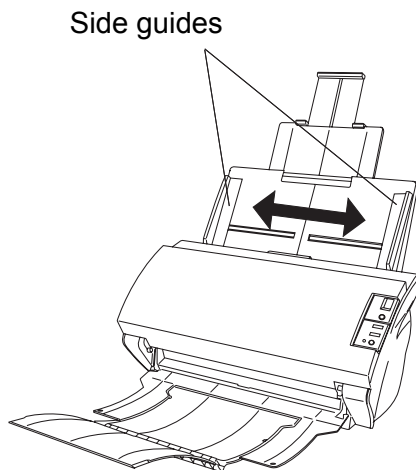

The stacker prevents document sheets from being scattered after they were scanned.

Use the stacker as follows:

1. Lift the stacker toward you by using your fingertips and the handle on the scanner.

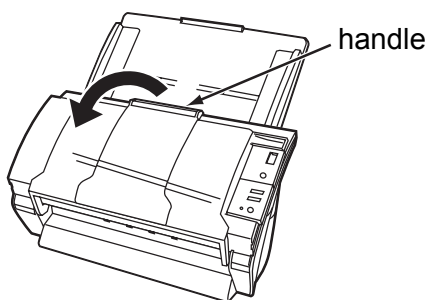

2. Lift the paper stop and extend it toward you by using your fingertips and the indentations on the stacker.

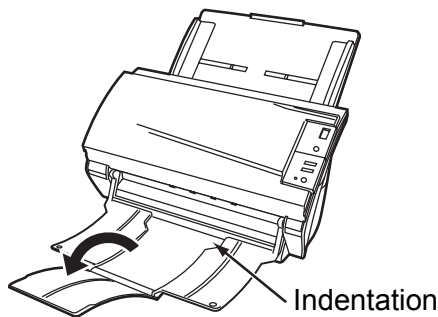

6. Start up the scanner application, and then scan the document.

For details on how to scan documents using the ScandAll PRO application, refer to section 1.5 "How to Use ScandAll PRO" on page 29.

1.3 Scanning Documents

This section explains how to scan documents with this scanner.
The following is a basic procedure for scanning documents:

1. Place a document on the scanner.

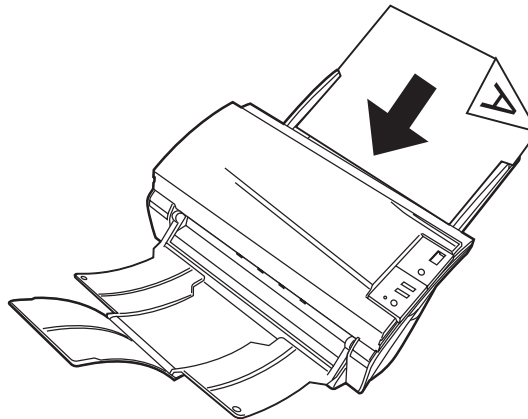

2. Launch an application you want to use for scanning.

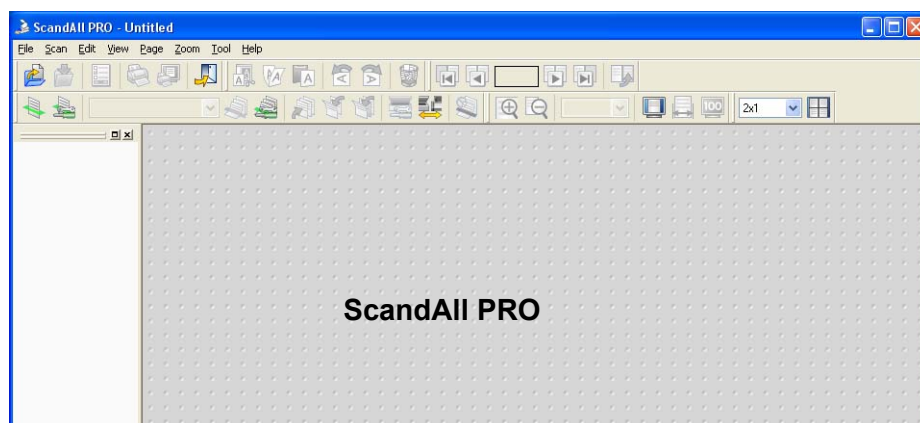

3. Select a scanner to use.

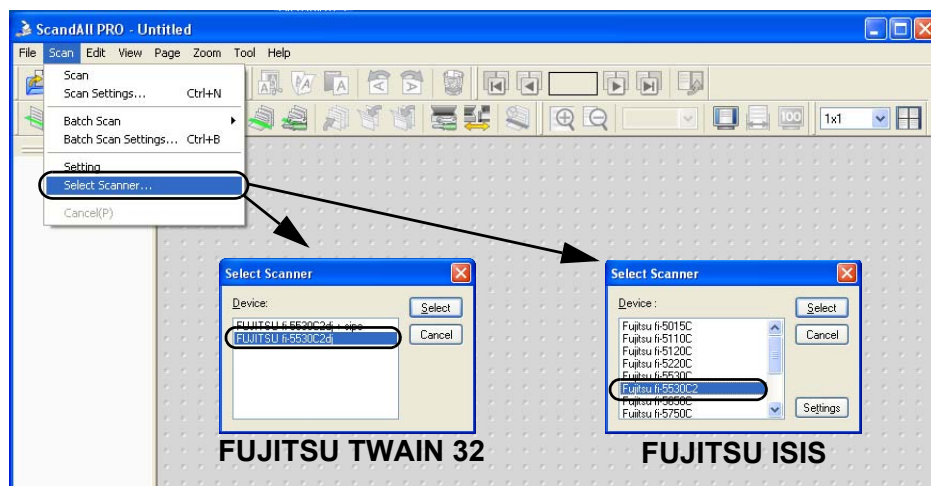

- In the application, invoke a scanner driver.

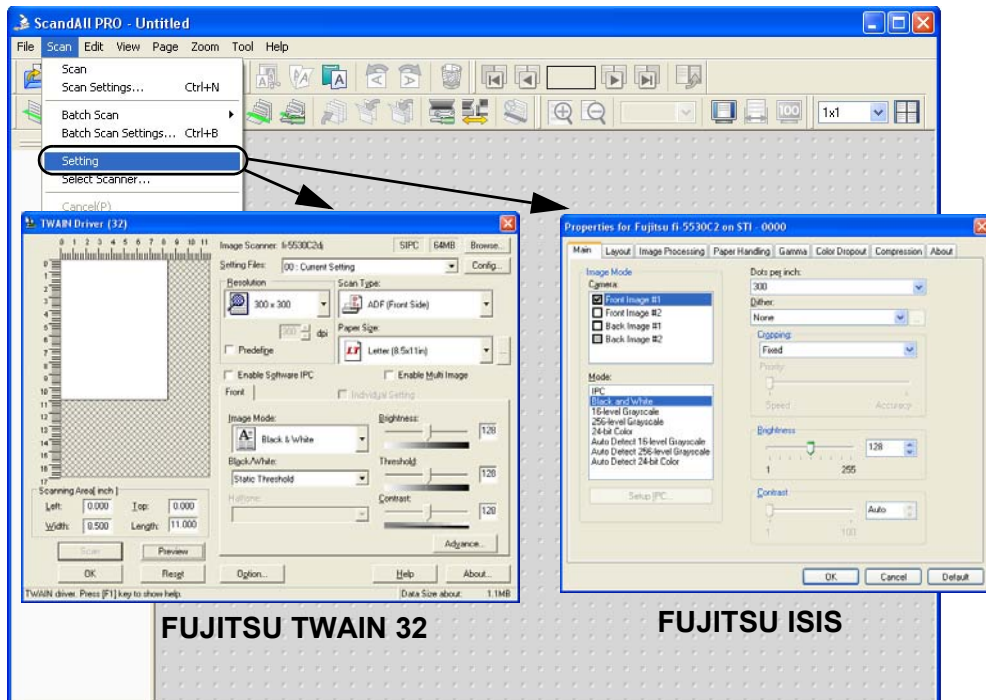

- In the driver setup dialog box, configure settings for scanning.
- Scan the document.

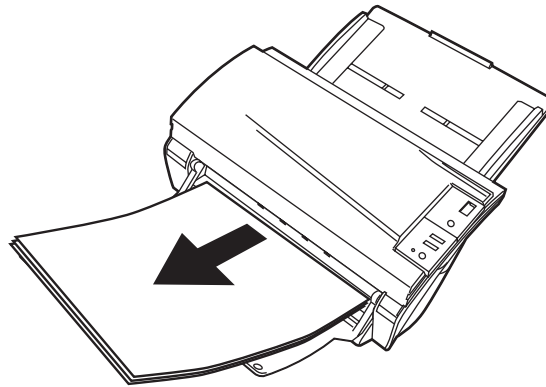

- Save the scanned document image files.



- In this section, screenshots taken in ScandAll PRO are used as examples. Depending on the application you use, procedures and operations may differ from those examples herein.
- For more information about how to scan documents by using ScandAll PRO, refer to section "1.5 How to Use ScandAll PRO" on page 29. If you want to use other applications for scanning, refer to the respective manuals that come with the applications.

1.4 How to Use Scanner Drivers

To scan documents with the scanner, a scanner driver and application supported by the driver are prerequisites. This scanner is accompanied with two drivers; one is a TWAIN-compliant driver, FUJITSU TWAIN 32 Scanner Driver, and the other is an ISIS-compliant driver, FUJITSU ISIS Scanner Driver; and an application named ScandAll PRO, which supports both the drivers FUJITSU TWAIN 32 and FUJITSU ISIS.

In this section, how to use these drivers is described.

For information about how to use ScandAll PRO and how to invoke a scanner driver via ScandAll PRO, refer to section "1.5 How to Use ScandAll PRO" on page 29.

■ FUJITSU TWAIN 32 Scanner Driver

FUJITSU TWAIN 32 Scanner Driver is a driver for scanning documents with the scanner based on a TWAIN-compliant application.

Usually, you can configure the scanner settings in the scanner driver's setup dialog box, invoking a scanner driver via an application. (Depending on the application settings, this setup dialog box may not appear.)



HINT

How to invoke a scanner driver varies depending on the application. For details, refer to the manual or help of the application you use. For information about how to invoke a driver via ScandAll PRO, refer to section "1.5 How to Use ScandAll PRO" on page 29.

FUJITSU TWAIN 32 Scanner Driver Setup

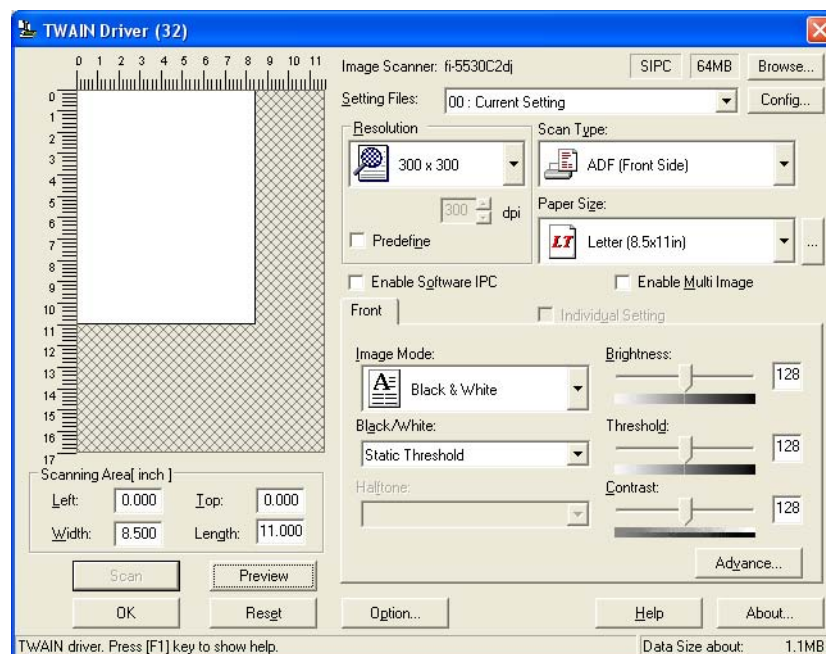

Configure FUJITSU TWAIN 32 Scanner Driver settings in the dialog box above.
Major setting items are listed below.

* For details on each function, refer to "TWAIN Driver Help."

Resolution

You can specify the resolution for scanning images.

Default values are selectable from the drop-down list, and a [custom] value (can be specified in increments of 1 dpi from 50 to 600 dpi) can also be selected by clicking a pair of up/down buttons.

By marking the [Predefine] checkbox, you can select one of three predefined settings, [Best], [Better], and [Normal], and this allows you to scan documents simply and quickly. You can also set values of [Best], [Better], and [Normal] as desired in a window that appears when the [...] button is clicked.

Scan Type

You can specify the feeding method, the side(s) to be scanned (Front Side, Back Side, Duplex) or details of Long page (the size of documents longer than A3).

Paper Size

You can select the size of documents to be scanned from the list.

Windows for customizing the paper size will appear when you click the [...] button.

You can save any document size as a customized setting (up to three) or for changing the order of paper sizes in the list.

Image Mode

You can specify the image type to output the scanned documents.

Black & White Documents are scanned in binary (black and white) mode.

Halftone Documents are scanned through halftone processing in binary (black and white) mode.

Grayscale Documents are scanned in gradations from black to white. In this mode, you can select 256 gradations or 4 bit (16 gradations).

Color Documents are scanned in color mode. In this mode, you can select 24 bit Color, 256 Color, or 8 Color.

[Scan] Button

Clicking this button starts scanning documents with the current settings.

[Preview] Button

Documents are scanned preliminarily before the actual scanning.

You can confirm the image of the documents in the preview window.

[OK]/[Close] Button

Clicking this button saves the current settings and closes this window.

[Reset] Button

This button is used to undo changes of settings.

[Help] Button

Clicking this button opens the [FUJITSU TWAIN 32 Scanner Driver Help] window. The window also opens by pushing the [F1] key.

[About] Button

Clicking this button opens an information window about the FUJITSU TWAIN 32 Scanner Driver's version.

[Option] Button

You can set options in the dialog box below.

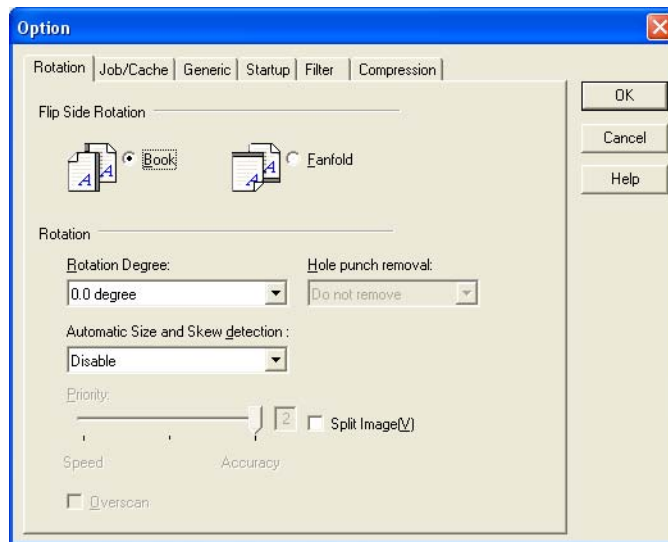

[Rotation] Tab

Select this tab when configuring settings for the image rotation, document size and skew detection, overscan, hole punch removal, and split image.

[Job/Cache] Tab

Select this tab when setting cache mode, multifeed detection, blank page skipping, etc.

[Generic] Tab

Select this tab to change the unit displayed in the Setting Window for the FUJITSU TWAIN 32 Scanner Driver. Select [mm], [inch], or [pixel].

[Startup] Tab

Select this tab for configuring settings on the Scanner Operation Panel.

[Filter] Tab

Select this tab for setting the image processing filter(s).

Page Edge Filler: Fills up the margins of the scanned document images with a selected color.

Digital Endoser: A character string (alphanumerics) can be added in the scanned document.

[Compression] Tab

Select this tab for setting the compression rate of JPEG Transfer.

[Advance] Button

Click this button for settings of the advanced image processing.

You can set Edge Extract, Gamma Pattern, Dropout Color, Reverse, etc.

[Config] Button

Click this button for configuring the Setting Files.

You can save the changes made to a Setting File. From the next scanning, a set of settings are quickly switched by using these Setting Files.

For details of each function, refer to the "FUJITSU TWAIN 32 Scanner Driver Help."

■ FUJITSU ISIS Scanner Driver

FUJITSU ISIS Scanner Driver is a driver software used to scan documents with a scanner from an ISIS-compliant application.

Usually, you configure settings for scanning in the setup dialog box of the scanner driver, which is invoked from an application. (Depending on the application setting, the setup dialog box may not be displayed.)



How to invoke a scanner driver varies depending on the application. For details, refer to the manual or help of the application you use.

For information about how to invoke a driver via ScandAll PRO, refer to section "1.5 How to Use ScandAll PRO" on page 29.

FUJITSU ISIS Scanner Driver Setup

[Main] Tab

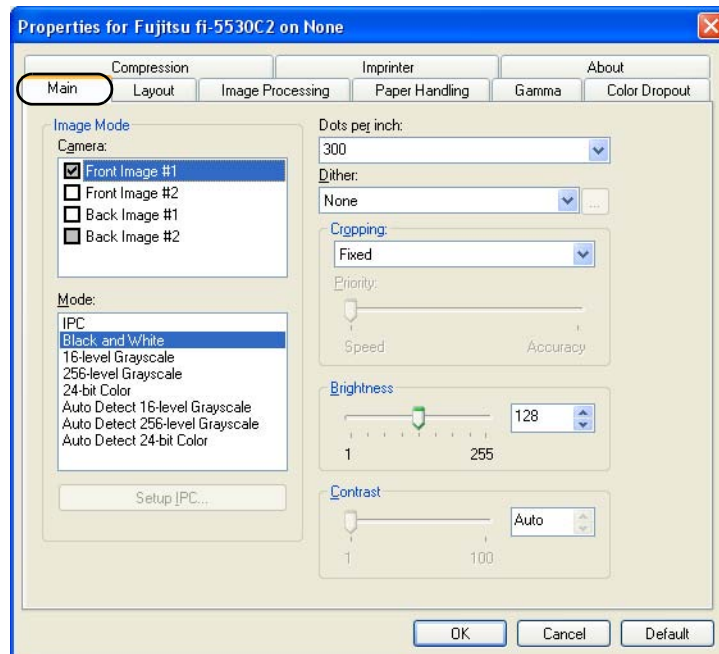

Camera

You can select a side or sides to scan.

The marked checkbox side is targeted for scanning.

When you mark only the Front Image checkbox, simplex scanning is performed. When you mark both the Front Image and Back Image checkboxes, duplex scanning is performed.

You can also specify two settings (#1/#2), Color/Grayscale and Binary (black-and-white), for each side, and output two types of images at a scan (multi-image).

Settings configured in this dialog box take effect on the selected side or sides (Front Image #1/Front Image #2/Back Image #1/Back Image #2).



If you select Color or Grayscale mode for a side (Front Image #1 or Back Image #1), you can select only Binary (black-and-white) mode for the same side (Front Image #2 or Back Image #2, respectively). In turn, if you select Binary (black-and-white) mode for a side (Front Image #1 or Back Image #1), you can select either Color or Grayscale mode for the same side (Front Side #2 or Back Image #2, respectively).

Mode

You can select a color mode to use from the menu.

- IPC** : Documents are scanned in binary (black-and-white) mode with Image Processing Software Option. When this setting is selected, the [Setup IPC] button below becomes selectable. (This button is visible only if Image Processing Software Option is installed on the computer.)
- Black & White** : Documents are scanned according to a binary threshold. Black and white are distinguished based on this set threshold. This mode is suitable for scanning line drawings and text only documents.
- 16-level Grayscale** : Documents are scanned in 16 gray levels. In this mode, each pixel uses 4 bits.
- 256-level Grayscale** : Documents are scanned in 256 gray levels. In this mode, each pixel uses 8 bits.
- 24-bit Color** : Documents are scanned as 24-bit full-color images. This mode is suitable for scanning color photographs. More memory is used than in Grayscale mode.
- Auto Detect** : This mode automatically detects whether the scanned documents are color or binary (black-and-white). In this mode, color documents are output as color or grayscale images, and monochrome documents are output as binary (black-and-white) images. Under [Camera], configure settings for detected-as-color documents with #1, and configure settings for detected-as-black-and-white documents with #2.

[Setup IPC] Button

Click this button when configuring settings for scanning with Image Processing Software Option.



For how to configure settings for Image Processing Software Option, refer to "Image Processing Software Option USER'S GUIDE". To view "Image Processing Software Option USER'S GUIDE", from the [start] menu, select [All Programs] ⇒ [Image Processing Software Option] ⇒ [USER'S GUIDE].

Resolution

You can specify the number of pixels (dots) per inch.

Select a preset resolution from the list or type in any value (from 50 to 600, or 1200) in the box.

(If you enter a number from 601 to 1199, the resolution is automatically set to 300 dpi.)

The higher the resolution, the more memory is required.

Halftone

You can select a halftone pattern. This setting is available when [Black and White] is selected under [Mode].

Dither Pattern 0 : This setting is suitable for scanning highly-colored photographs.

Dither Pattern 1 : This setting is suitable for scanning highly-colored documents containing both text and photographs.

Dither Pattern 2 : This setting is suitable for scanning lightly-colored photographs.

Dither Pattern 3 : This setting is suitable for scanning lightly-colored documents containing both text and photographs.

Error Diffusion : This function minimizes differences between a target pixel and pixels near the target.

Download : This function processes gray tone images with the dithered pattern downloaded.

Cropping

Select how to crop scanned document images to output.

Fixed : Scanned document images are output in a specified size.

Detect Length : The rear end of a scanned document is detected and scanning is performed for the original length. When shorter sheets are included in a batch of documents to scan, output images are adjusted to their original size.

Automatic : The page size of the scanned documents is automatically detected and the images are output in the detected page size. The skew of documents is also automatically detected and corrected to output correct images.

Brightness

You can set the brightness of the entire image. Specify a number from 1 (darkest) to 255 (brightest) as the brightness value. The higher the value, the brighter the image. The lower the value, the darker the image.

Contrast

You can set the contrast of the scanned image. Specify a number from 1 (low [soft]) to 100 (high [sharp]) to increase brightness for the entire image. Select a higher value to emphasize the difference in brightness between the light and dark areas of the image.

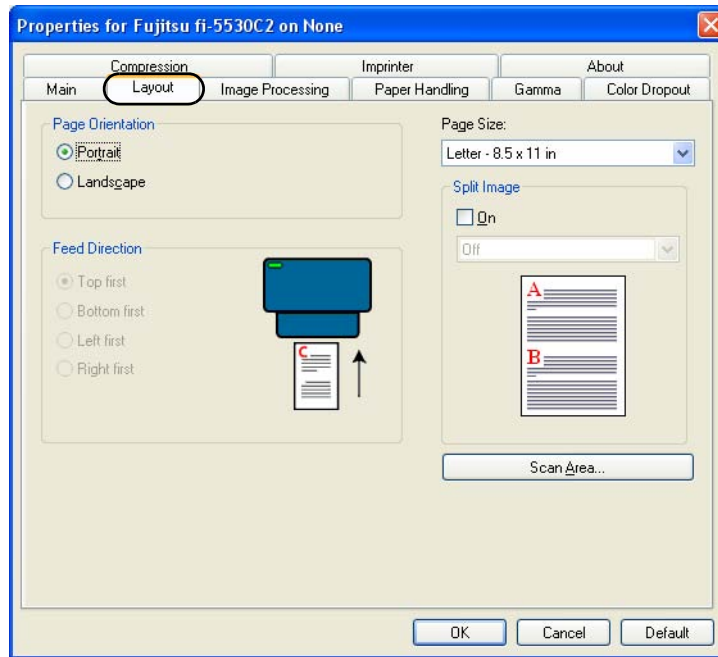
[Layout] Tab**Page Orientation**

You can select the page orientation (Portrait or Landscape).

Page Size

You can specify the paper size of documents to be scanned. Select a size from the drop-down list.

Split Image

You can split a scanned image into two.

Scan Area

Clicking this button displays the [Scan Area] dialog box.

You can specify an area to be scanned for a page of the selected size. By dragging the rectangle on the page with the mouse, you can change the size of the area. You can also specify the area by typing in numbers in the boxes.

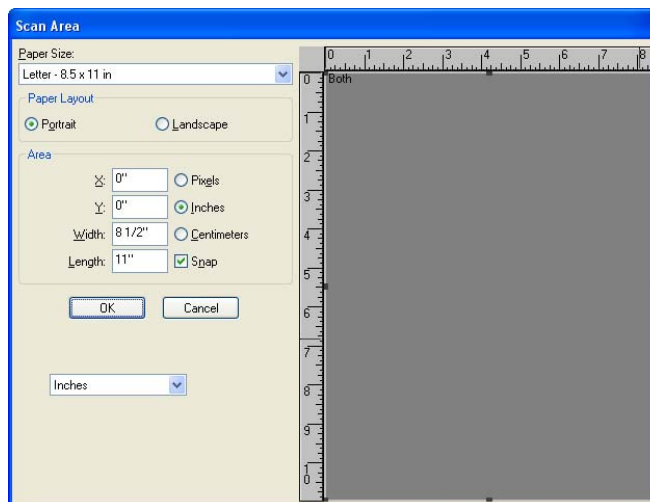

[Image Processing] Tab

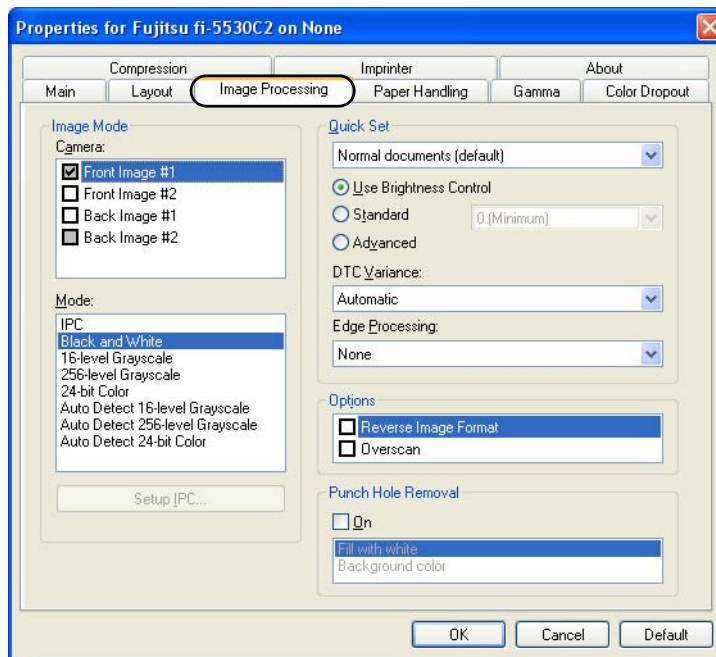

Quick Set

Some image-processing-related settings, which are commonly used, are readily available. Select a setting pattern, and you do not have to configure settings one by one. The following setting patterns are available (Selectable only when [Black and White] is selected under [Mode]):

- | | |
|-----------------------------------|---|
| Normal documents (default) | : This setting pattern is suitable for scanning business documents often handled in the office. |
| Advanced DTC | : Any types of documents are binarized in good conditions. Even if you scan documents containing light text, text on the colored background, and color charts, which do not lend themselves to scanning based on the ordinary binarization, you can obtain high-quality images. |
| NCR forms with background removed | : You can remove the background and smooth out jaggies in the image. |
| Magazines, Brochures, etc. | : This setting pattern is suitable for scanning magazines and brochures, which contain both text and images. |
| Custom Settings | : You can specify the following image-processing-related settings separately. |

DTC Variance

You can select a DTC Variance setting depending on the brightness of the image.

Edge Processing

You can select a setting depending on how sharp you want to make the image.

Low, Mid, High: Outlines of images are emphasized. Select a setting from Low, Mid, and High.

Smoothing : Jaggies are smoothed.

Hole Punch Removal

When scanning punched documents that have punch holes on them, their images are output with punch holes removed.

Fill with white : Punch hole marks are filled with white.

Background color : Punch hole marks are filled with the most used color around the punch holes.

When scanning a color document, select [Background color]. If you select [Fill with white], punch holes will be filled with white.

Reverse Image Format

You can output reversed images.

Overscan

You can set the overscan function. Documents are scanned in a paper size larger than the one specified in the [Paper Size] drop-down list.

[Paper Handling] Tab

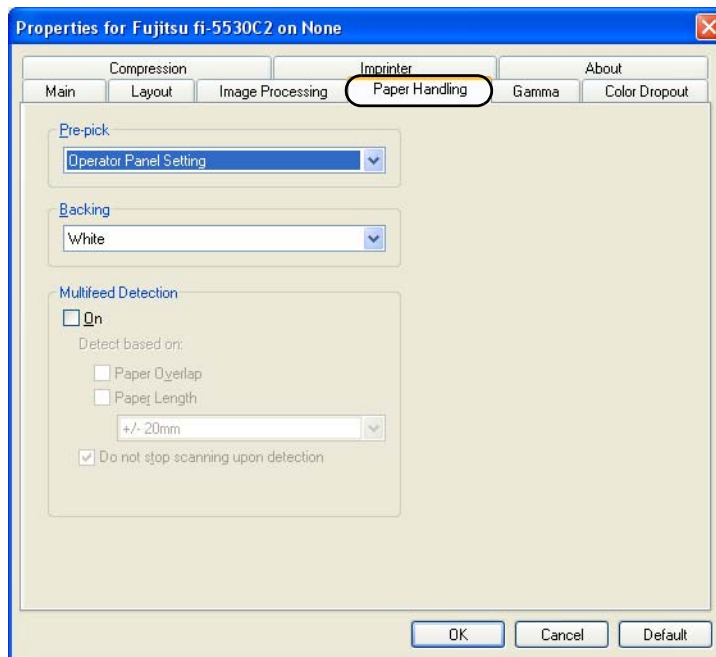

Pre-pick

Pre-picking is a function that prepares the next document for scanning, feeding it to the position at which the scanning starts beforehand. You can specify whether you want to enable Pre-picking or not from this drop-down list.

Backing

You can specify the background color, white or black.

Multifeed Detection

Multifeed refers to an error that occurs when more than one sheet of paper is fed into the ADF at the same time. You can specify based on what (overlap or length) a multifeed error can be detected so that you can stop scanning at error detection and receive an error message.

Do not stop scanning upon detection

If this checkbox is marked, the scanner ignores multifeed errors and continues scanning.

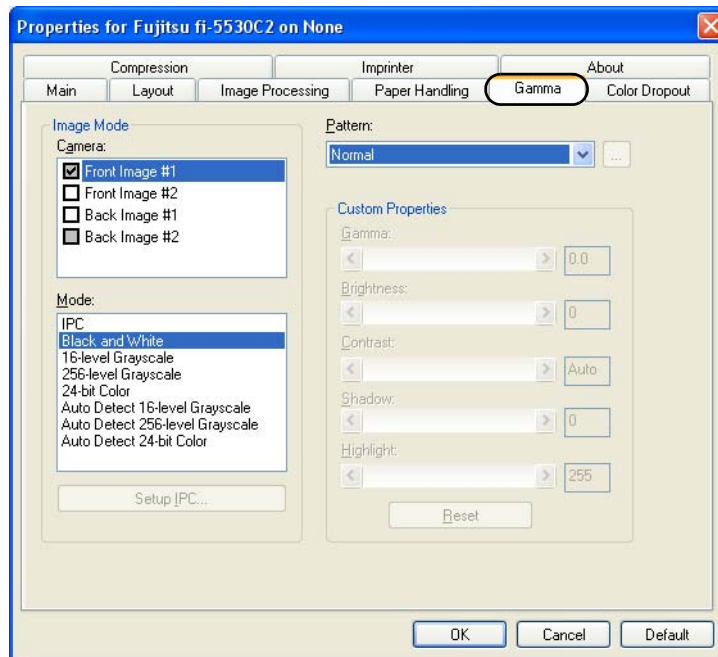
[Gamma] Tab**Pattern**

You can select one of five Gamma patterns from Normal, Soft, Sharp, Custom, and Download.

Custom Properties

You can specify custom properties (Gamma, Brightness, Contrast, Shadow, and Highlight) only when you select [Custom] as a Gamma pattern. Type in a numerical value in each box or click the forward/backward arrows to increase/decrease the numerical value. Of those items, [Shadow] and [Highlight] can be specified only when a Color or Grayscale setting is selected under [Mode].

[Color Dropout] Tab

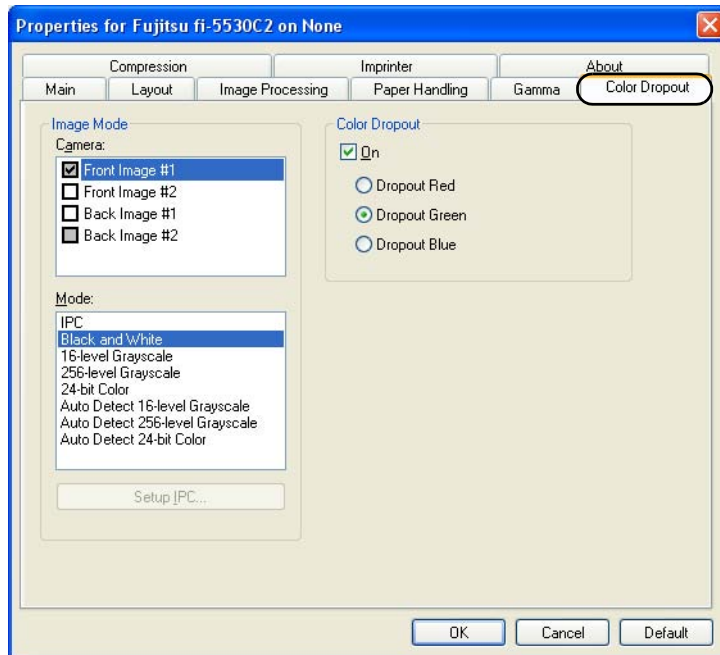

Color Dropout

Any of three primary colors (red-green-blue) can be dropped out from document images. For example, when scanning text in black with the red frame, selecting red color scans only text in black.

This setting is available only when Black and White or a Grayscale setting is selected.

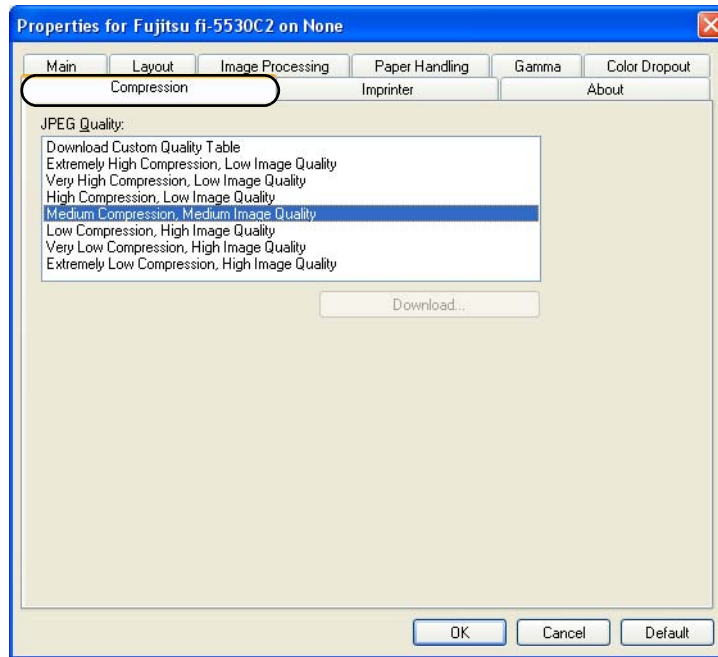
[Compression] Tab**JPEG Quality**

You can specify compression levels and image quality for scanning in Color or Grayscale mode.

[Imprinter] Tab

You can configure settings for using the imprinter option (to be purchased separately). This tab is not displayed unless the imprinter option is installed.

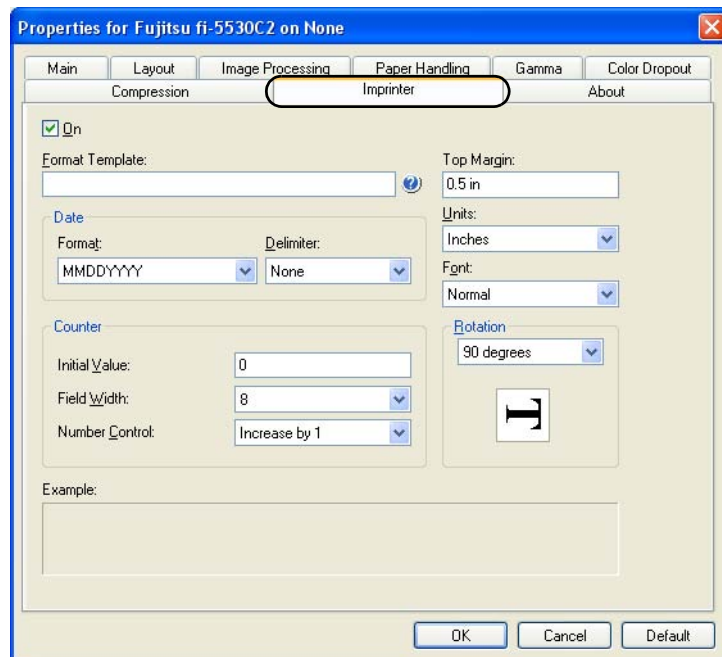

[ON] Checkbox

Marking this checkbox enables the imprinter function.

Format Template

Characters typed in this box are printed on documents. You can use the following characters:

- Alphabet : A to Z / a to z (single-width)
- Numerics : 0, 1 to 9 (single-width)
- Symbols : ! " \$ # % & ' () * + , - . / : ; < = > ? @ [\] ^ _ ` { | } (single-width)
- Year/Month/Day : %Y
- Time (HH:MM) : %T
- Counter : %S (Select from 3 to 8 as the number of digits.)
- Other : <single-width space>

You can type in up to 43 characters.



To print characters # and %, you have to type in ## and %% respectively because these are special characters. Take note that typing in only one character (#) displays the counter.

Date

You can specify how to indicate the date format.

- Format** : Type in the initial value.
- Delimiter** : Select a delimiter, which is a character that identifies the beginning or the end of a character string.

Counter

You can specify the rule to display the counter.

- Initial Value** : Set the initial value of the counter.
- Field Width** : Select the number of digits from 3 to 8.
- Number Control** : Select the increment of the counter value.

Top Margin

You can set the distance between the top of the page and the top of the first line printed on the page with a numeric.

- Range** : 0.5 to 10.5 in. (1.27 to 26.7 cm)
- Minimum unit** : 0.1 in. (0.01 cm)

Units

You can specify the unit of the top margin; in inch, in cm, or in pixel.

Font

You can specify the font style from Normal, Bold, and Narrow for printing characters.

Rotation

You can specify the text direction for printing characters.

[About] Tab

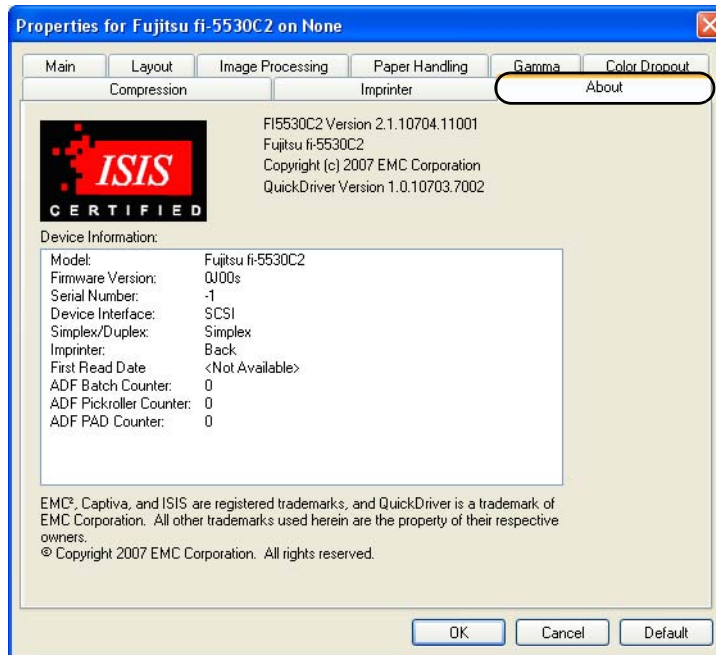

On this tab, you can view the information about the ISIS driver and the scanner connected to your personal computer.

1.5 How to Use ScandAll PRO

ScandAll PRO is software for scanning images, which is in conformity with both TWAIN/ISIS standards. Using FUJITSU TWAIN 32 or FUJITSU ISIS together with ScandAll PRO allows you to create document images.

The following explains how to scan documents with the scanner through ScandAll PRO.

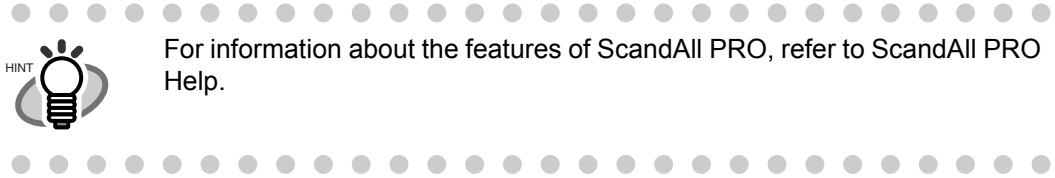

For information about the features of ScandAll PRO, refer to ScandAll PRO Help.



■ Launching ScandAll PRO

From the [Start] menu, select [All Programs] ⇒ [Fujitsu ScandAll PRO] ⇒ [Fujitsu ScandAll PRO].

⇒ ScandAll PRO starts up.

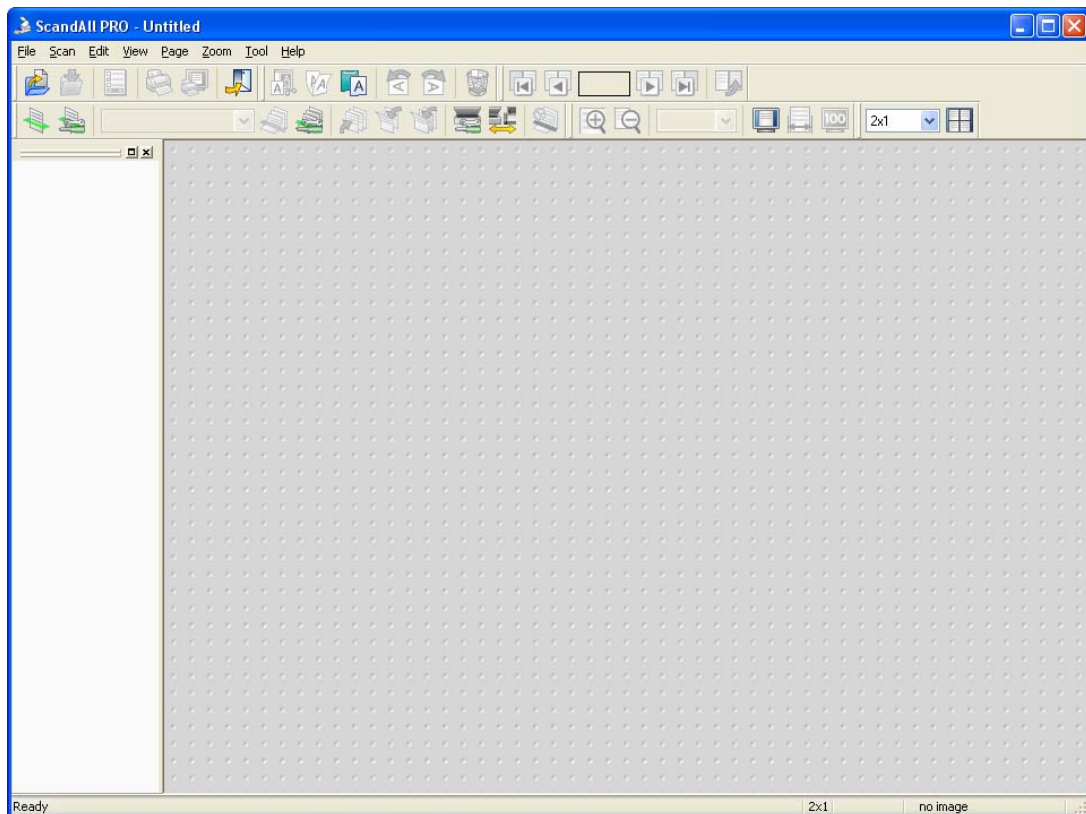

■ Selecting a Scanner Driver

ScandAll PRO supports both TWAIN and ISIS standards and allows you to invoke either the TWAIN driver or the ISIS driver for scanning images with the scanner. This scanner comes with two drivers, FUJITSU TWAIN 32 Scanner Driver and FUJITSU ISIS Scanner Driver, which you can use with this scanner.

The following explains how to select a scanner driver with ScandAll PRO (how to switch between TWAIN and ISIS drivers.)



- 1) From the [Tool] menu, select [Preferences].

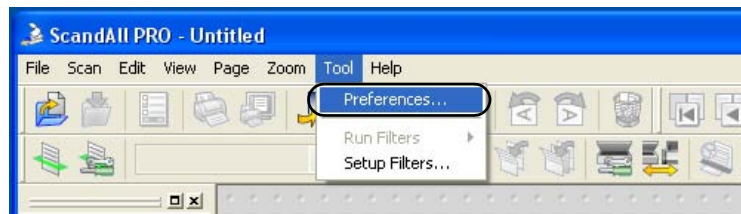

⇒ The [Setup] dialog box appears.

- 2) On the [Scan] tab, under [Driver], select either of drivers.
To use FUJITSU TWAIN 32 Scanner Driver, select [TWAIN].
To use FUJITSU ISIS Scanner Driver, select [ISIS].

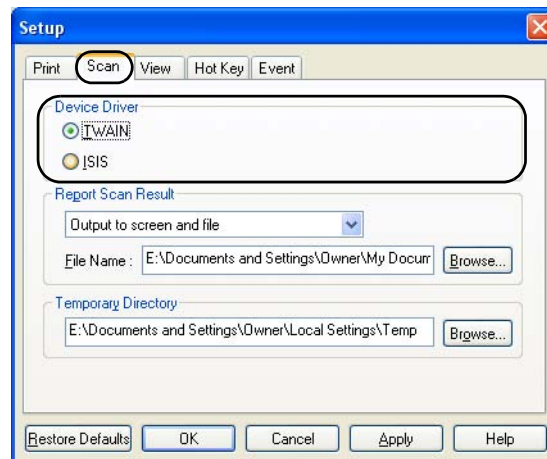

- 3) Click the [OK] button to close the [Setup] dialog box.

■ Selecting a Scanner

To scan documents with a scanner, you have to select its name from the list beforehand. The following explains how to select a scanner to use.

- 1) From the [Scan] menu, select [Select Scanner].

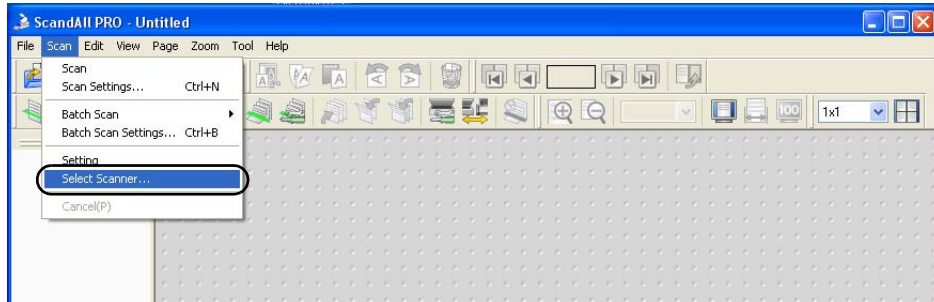

⇒ The [Select Scanner] dialog box appears.

- 2) Select a scanner you want to use.

When the driver is FUJITSU TWAIN 32, select [FUJITSU fi-5530C2dj], and then click the [Select] button.

When the driver is FUJITSU ISIS, select [FUJITSU fi-5530C2], and then click the [Select] button.

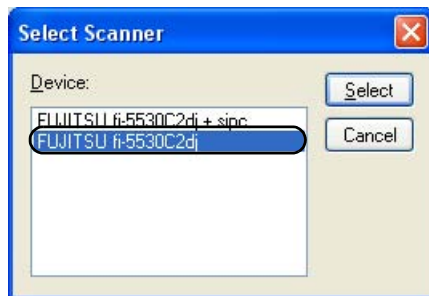

FUJITSU TWAIN 32



FUJITSU ISIS

■ How to Display the Scanner Driver Setup Dialog Box

You can configure settings for scanning documents with the selected scanner in the setup dialog box of a scanner driver.

Select the [Scan] menu, and then select [Setting] to display the setup dialog box.

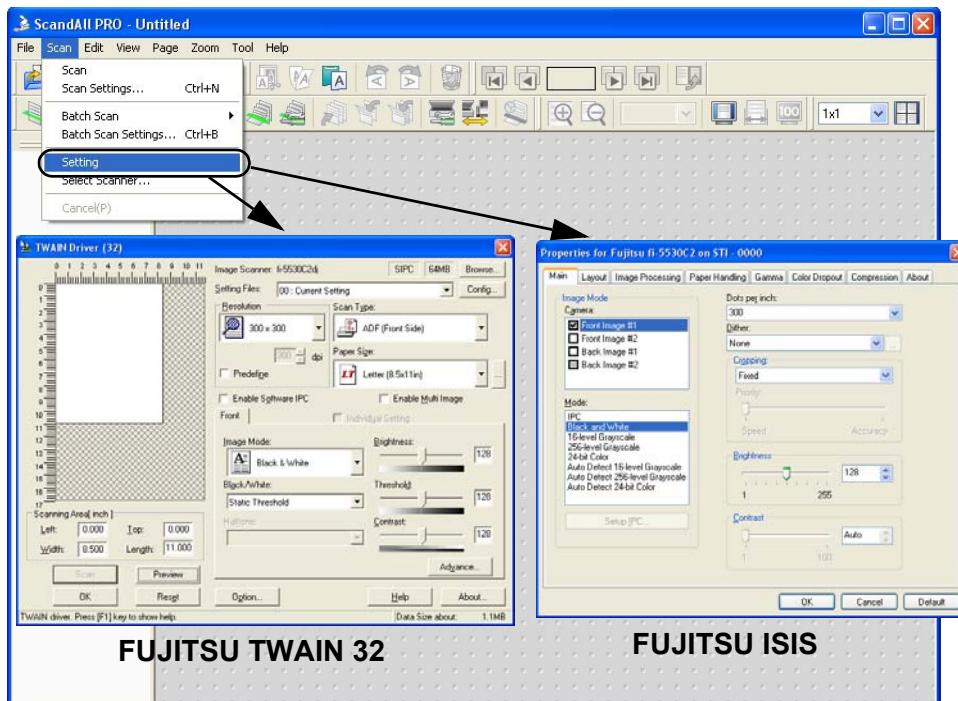

For information about setting items you can configure, refer to section "[1.4 How to Use Scanner Drivers](#)" on page 12.

■ How to Scan Documents

With ScandAll PRO, you can scan documents with a scanner, in either of two ways:

Scan ([page. 33](#))

You have to configure settings, such as the file format, destination, and scanning parameters, every time you scan a document.

Use [Scan] when you want to scan a small amount of documents as necessary.

Batch Scan ([page. 37](#))

You may want to use the same settings repeatedly. You can configure settings such as the scanning parameters, destination, image-related properties, and an application to link with and create a profile with these settings saved.

You can create more than one profile beforehand, so you do not have to configure settings every time you scan documents. You only switch between profiles.

Use [Batch Scan] when you want to scan a large volume of documents using various profiles.

■ Scan

- 1) Place the document on the scanner.
For information about how to place documents, refer to section "[1.2 Placing Documents on the ADF](#)" on page 6.
- 2) From the [Scan] menu, select [Scan Settings].

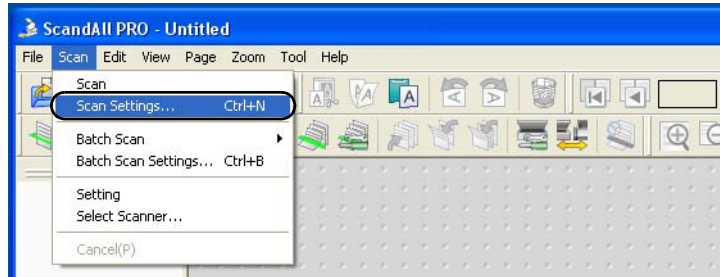

Or, select the [Scan Settings] button () on the toolbar.
⇒ The [Scan Settings] dialog box appears.

- 3) In the [Scan Settings] dialog box, configure various settings for saving scanned document images.

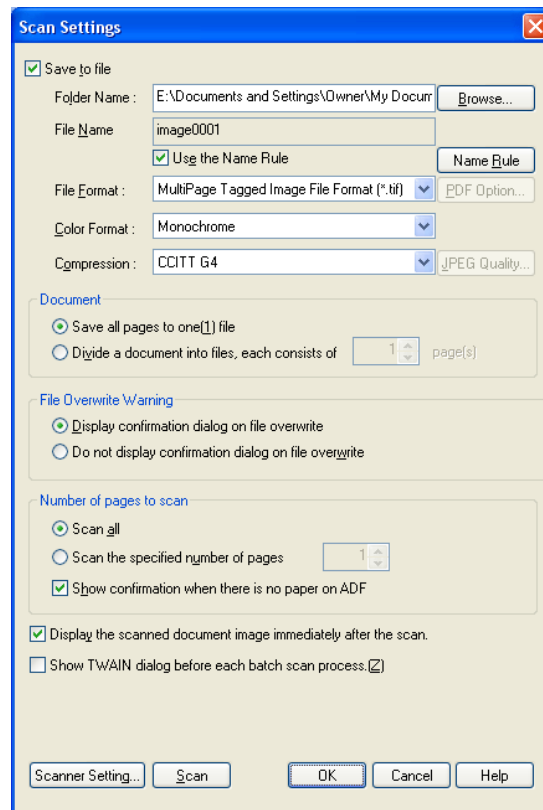

[Save to file] Checkbox

To save scanned document images immediately after scanning, mark this checkbox. If you want to verify scans before saving them to file, clear this checkbox.

Folder Name

You can specify a folder to save scanned document images.
Type in a full path in the box or click the [Browse] button to select a desired folder.

File Name

A file name used to save scanned document image files is displayed.
You may want to change the file name. Click the [Name Rule] button to display the [Name Rule] dialog box, and change the naming rule. When creating multiple image files at a scan, you can specify how to name those files.

[Use the Name Rule] Checkbox

Mark this checkbox when you want to use the name rule for file names.
Clear this checkbox when you want to specify a file name on this dialog box.

File Format

You can select a file format to save image files.
Bitmap (*.bmp), TIFF (*.tif), JPEG (*.jpg/*.j2k), or PDF (*.pdf), PDF/A (*.pdf) can be selected.
(When you select a multi-page format such as MultiPage TIFF , PDF, and PDF/A, multiple images can be saved in a file.)

Color Format

You can specify color mode.

Compression

You can select how to compress files to save.

Document

When scanning a document containing more than one page, you can specify whether to create one file containing all pages or to divide into files each containing the specified number of pages.
This becomes selectable only when a multi-page format is selected.

File Overwrite Warning

You can select whether you want to receive a confirmation message when scanned document image files with the same names already exist in the destination folder. If you select [Do not display confirmation dialog], those files are replaced with new ones.

Number of pages to scan

You can specify the number of pages to be scanned at a scan.

[Display the scanned document image immediately after the scan] checkbox

Specify whether to preview a scanned document image or not.
By default, this checkbox is marked.
If memory becomes insufficient because the file size of a scanned document image is too large to display, clear this checkbox.
(*Only when the [Save to file] checkbox is marked, this checkbox can be cleared.)

[Show TWAIN dialog before each batch scan process] Checkbox
 Marking this checkbox displays the setup dialog box at a scan when the TWAIN driver is used for scanning.
 (* When FUJITSU ISIS Scanner Driver is used, this checkbox is not available.)

- 4) Click the [Scanner Setting] button.

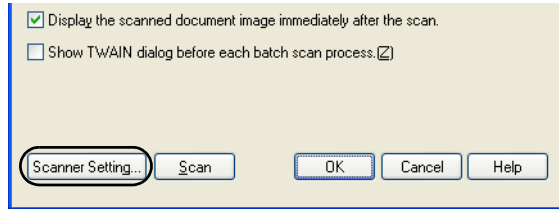

⇒ The scanner driver setup dialog box appears.

- 5) Configure various settings for scanning documents.

For more details about the settings, refer to section "1.4 How to Use Scanner Drivers" on page 12.

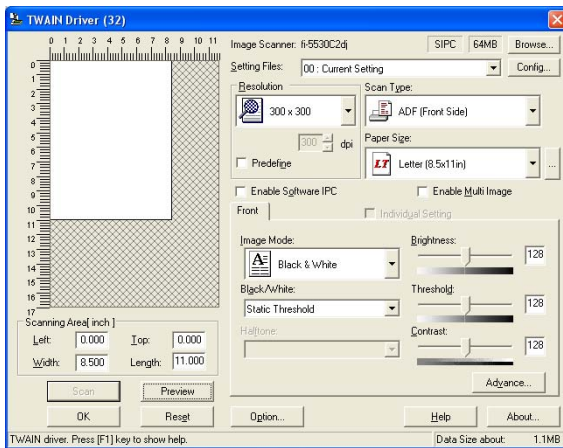

FUJITSU TWAIN 32

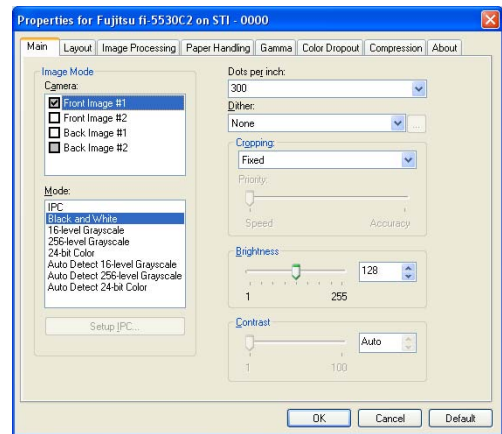

FUJITSU ISIS

- 6) When you finished setting, click the [OK] button in the dialog box (FUJITSU TWAIN 32 Scanner Driver/ FUJITSU ISIS Scanner Driver).

⇒ You are returned to the [Scan Setting] dialog box.

- 7) Click the [Scan] button.

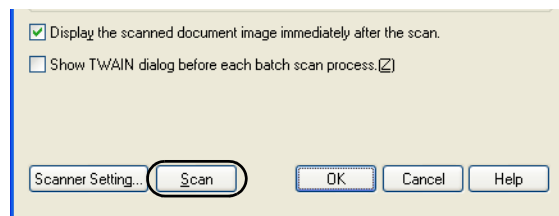



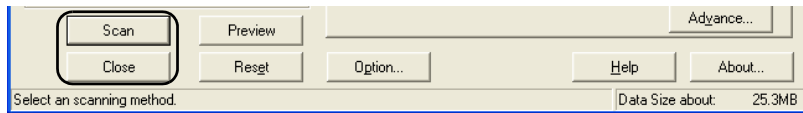

When you use FUJITSU TWAIN 32 Scanner Driver, clicking the [Scan] button may display the scanner driver's setup dialog box. If so, you can also change settings in the dialog box displayed. Click the [Scan] button to scan documents. Click the [Close] button when you finish scanning.

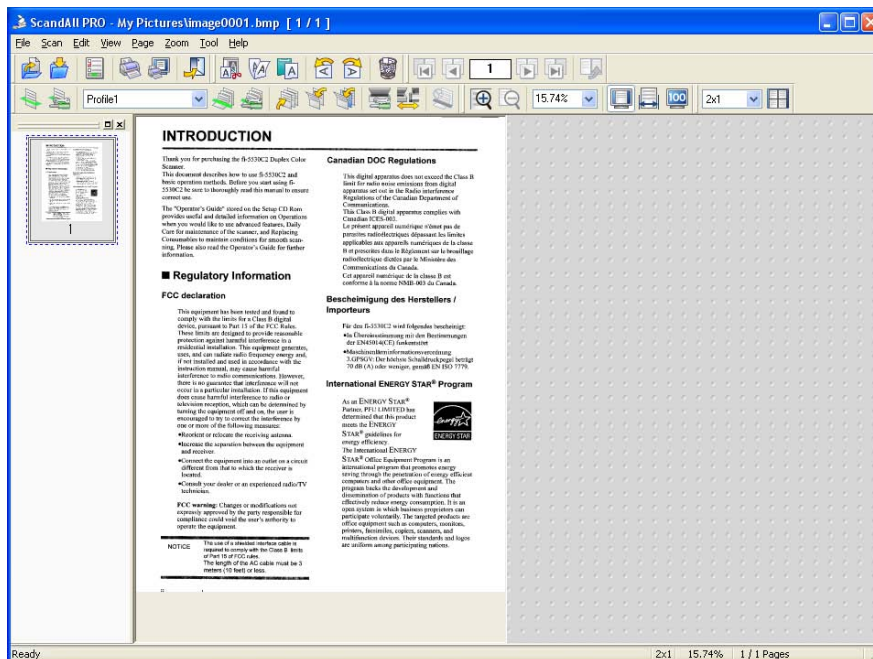

If you do not want to display the scanner driver's dialog box after clicking the [Scan] button in step 7, do the following: In the [Scan Settings] dialog box, clear the [Show TWAIN dialog before each batch scan process] checkbox.

⇒ A document is scanned with the scanner, and the scanned document image is displayed on the ScandAll PRO window, and then the image is saved to file.



- If you do not mark the [Save to file] checkbox in the [Scan Settings] dialog box, scanned document images are not saved. To save the files, from the [File] menu, select [Save As].
- To scan the next document with the same settings, from the [Scan] menu, select [Scan]. Or, click the [Scan] button () on the toolbar.

For information about other scanning operations, refer to chapter "2 SCANNING VARIOUS TYPES OF DOCUMENTS" on page 45.

For more details about the features and operations of ScandAll PRO, refer to [ScandAll PRO Help].

■ Batch Scan

You can save various settings as profiles beforehand.
Batch Scan allows you to scan documents by using those profiles.

<Creating/Editing Profiles>

1. From the [Scan] menu, select [Batch Scan Settings].

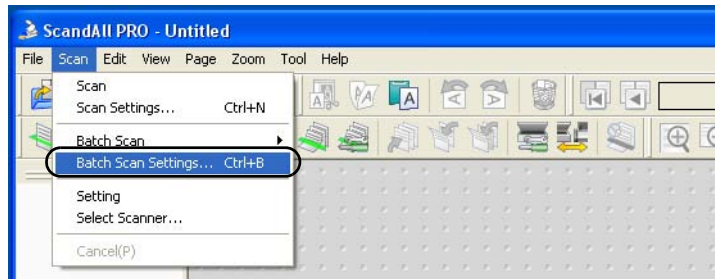

Or click the [Batch Scan Settings] button () on the toolbar.
⇒ The [Batch Scan Setting] dialog box appears.

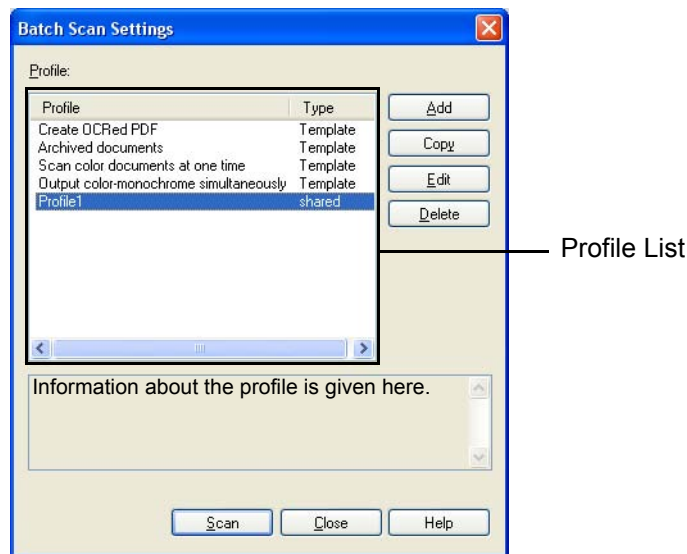

2. Do the following as necessary:

- To create a new profile:
Click the [Add] button.
⇒ A new profile appears in the [Profile Editor] dialog box.
(Go to step 3.)
- To create a new profile based on an existing profile:
Select a profile you want to use as the basis from the profile list, and then click the [Copy] button.
⇒ A new profile based on the selected profile appears in the [Profile Editor] dialog box.
(Go to step 3.)

- To change the settings of an existing profile:
 - Select a profile you want to change settings for, and click the [Edit] button.
 - ⇒ The selected profile appears in the [Profile Editor] dialog box.
 - (Go to step 3.)
- To delete an existing profile from the profile list.
 - Select a profile you want to delete, and then click the [Delete] button. When you see a confirmation message, click the [Yes] button.
 - ⇒ The selected profile is deleted.



If the [Type] of a profile in the profile list is [Template], it is a sample profile. It cannot be used for scanning documents. Use sample profiles as the basis for you to create new profiles.

3. In the [Profile Editor] dialog box, configure settings for scanning and saving scanned document images.

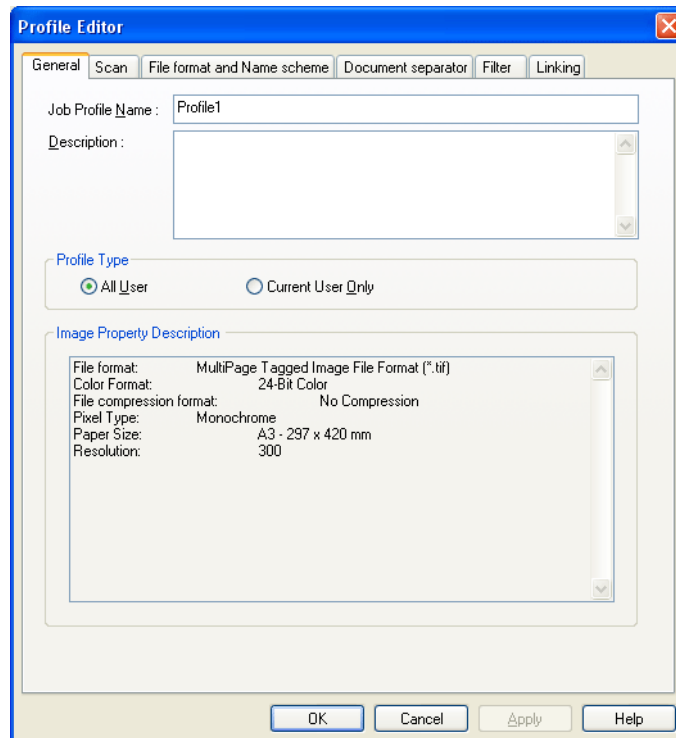

[General] Tab

You can type in a profile name and description, and select a profile type.

[Scan] Tab

You can configure settings for a scanner to use.

Clicking the [Detail Scanner Settings] button displays the setup dialog box of the scanner driver.

[File format and Name scheme] Tab

You can specify various parameters for saving scanned document images.

[Document separator] Tab

You can select how to separate documents.

Each separated document is numbered according to the set Name Rule.

[Filter] Tab

You can select a filter to use for scanning.

[Linking] Tab

You can select what to do with scanned document images after scanning; send by e-mail, upload to the FTP server or Microsoft® SharePoint Server, print with a printer, or open with an application.

* For details about the above settings, refer to ScandAll PRO Help.

4. Click the [OK] button.

⇒ You are returned to the [Batch Scan Settings] dialog box.

Added or copied profiles by using the [Add] or [Copy] button appear in the profile list.

<Scanning Documents>**A: From the menu (Method 1)**

1. Place the document on the scanner.

For information about how to place documents, refer to section "[1.2 Placing Documents on the ADF](#)" on page 6.

2. From the [Scan] menu, select [Batch Scan Settings].

⇒ The [Batch Scan Settings] dialog box appears.

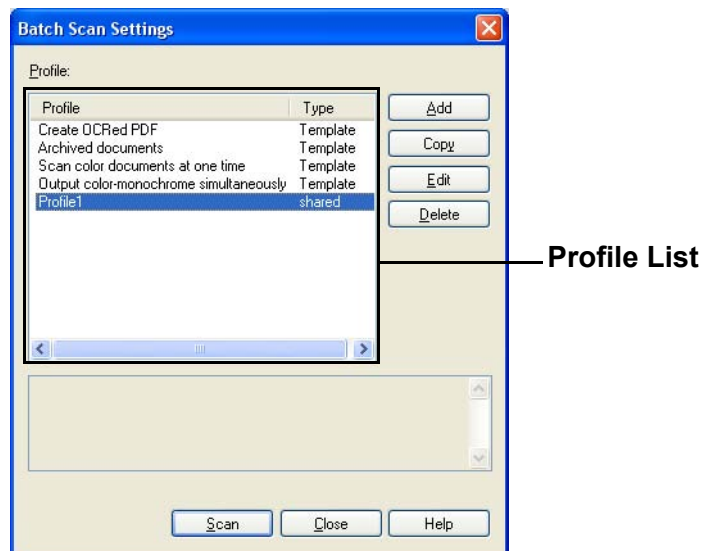

3. Select a profile you want to use for scanning.

4. Click the [Scan] button.

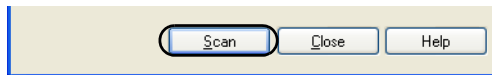

⇒ A document is scanned with the scanner, and the scanned document image is displayed on the ScandAll PRO window, and then the image is saved to file.

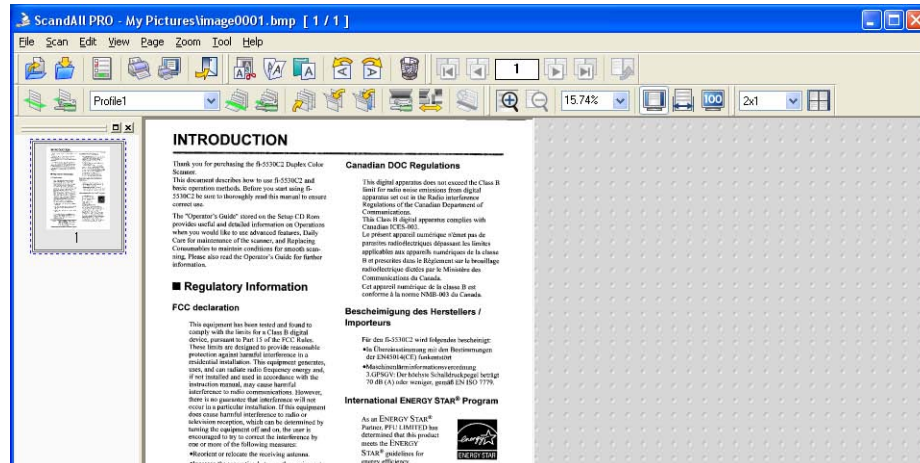

B: From the menu (Method 2)

1. Place the document on the scanner.

For information about how to place documents, refer to section "[1.2 Placing Documents on the ADF](#)" on page 6.

2. From the [Scan] menu, select [Batch Scan], and then select [a profile name you want to use].

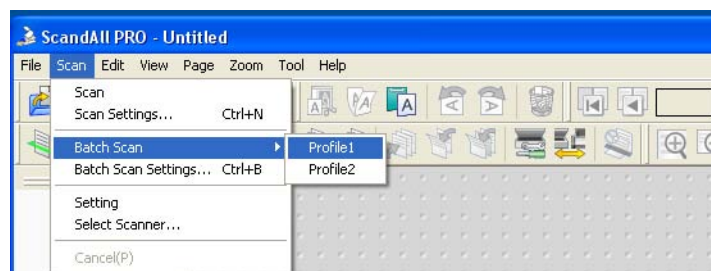

⇒ A document is scanned with the scanner, and the scanned document image is displayed on the ScandAll PRO window, and then the image is saved to file.

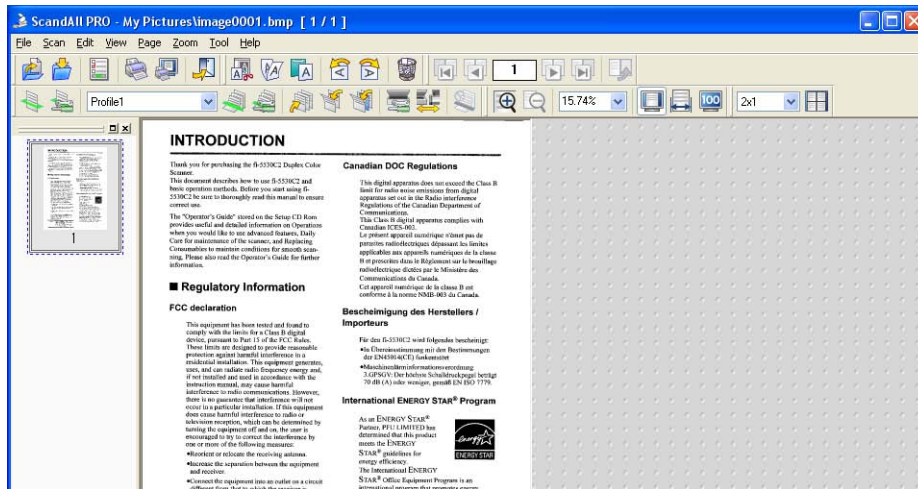



C: From the toolbar

1. Place the document on the scanner.

For information about how to place documents, refer to section "1.2 Placing Documents on the ADF" on page 6.

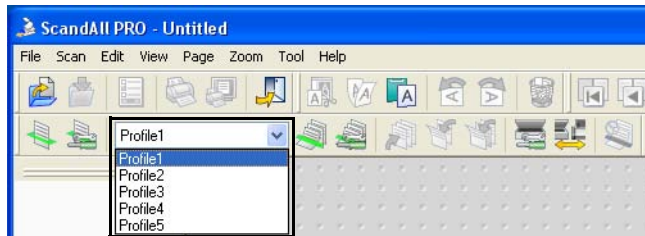
2. From the [Select the Batch File] drop-down list on the toolbar, select a profile to use.



3. Click the [Start Batch Scan] button () on the toolbar.

⇒ A document is scanned with the scanner, and the scanned document image is displayed on the ScandAll PRO window, and then the image is saved to file.

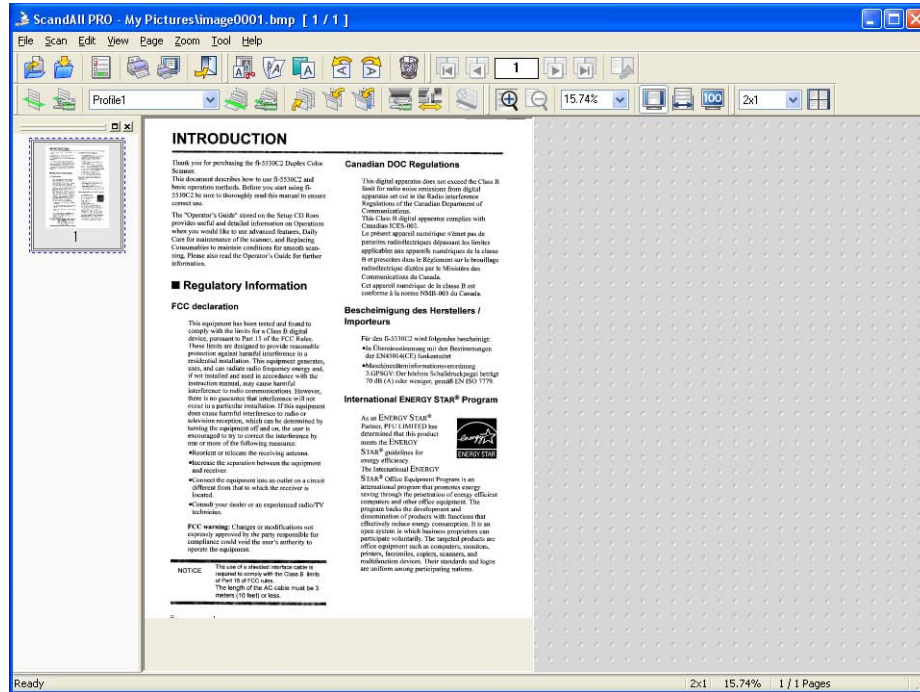

■ Canceling Scanning

When you want to cancel scanning, Scan or Batch Scan, do either of the following:

- From the [Scan] menu, select [Cancel].

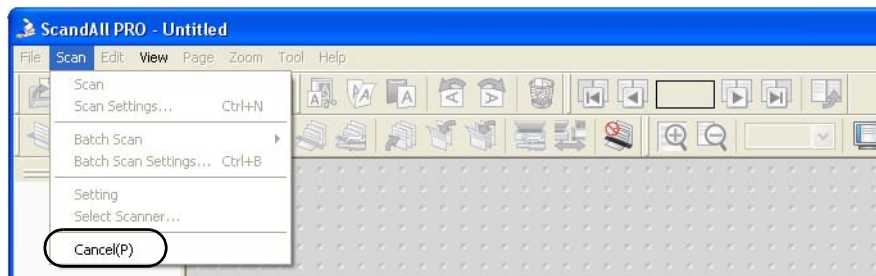

- On the tool bar, click the [Cancel] button



Chapter 2

SCANNING VARIOUS TYPES OF DOCUMENTS

This chapter describes how to scan various types of documents, using the combination of ScandAll PRO and FUJITSU TWAIN 32 Scanner Driver as an example.

In this chapter, Windows XP screenshots are used as examples.

The screens and operations provided herein may be different from actual ones if the operating system you are using is not Windows XP.

Please take note that, when FUJITSU TWAIN 32 is updated, the screens and operations herein may also be slightly different.

If so, refer to the document provided with the update.

2.1 Scanning Double-Sided Documents	46
2.2 Scanning Documents of Different Widths	47
2.3 Scanning Thin Documents.....	48
2.4 Scanning Documents Longer Than A3 Size.....	49
2.5 Saving Scanned Images in PDF Format	51
2.6 Excluding a Color from Images (Dropout Color)	62
2.7 Skipping Blank Pages	64
2.8 Detecting Multifeeds	66
2.9 Correcting Skew.....	71
2.10 To Output Multi-Images	74
2.11 Color/Monochrome Auto Detection	77
2.12 Splitting a Page in Two Pages	79
2.13 Removing Punch Holes from Images	81
2.14 Scanning by Pressing the Scan Button on the Scanner.....	84

2.1 Scanning Double-Sided Documents

1. Place the document on the ADF paper chute.

For details on how to place documents, refer to ["1.2 Placing Documents on the ADF" on page 6](#).

2. Launch ScandAll PRO.

From the [Start] menu, select [All Programs] ⇒ [Fujitsu ScandAll PRO] ⇒ [Fujitsu ScandAll PRO] in the order presented. Then, ScandAll PRO starts up.

3. From ScandAll PRO, display the setup dialog box of FUJITSU TWAIN 32.

For information about how to display the scanner driver's setup dialog box, refer to section ["1.5 How to Use ScandAll PRO" on page 29](#).

4. Select [Duplex] under [Scan Type].

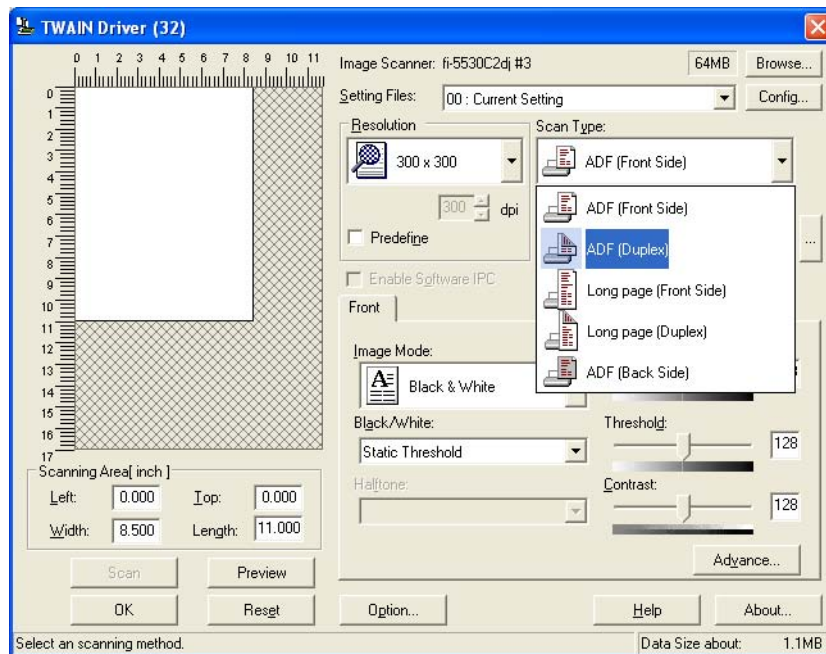

5. Click the [OK] button.

⇒ Changes made on this dialog box are saved and the setup dialog box of FUJITSU TWAIN 32 closes.

6. From the ScandAll PRO window, perform a scan.

For information about how to scan documents, refer to section ["1.5 How to Use ScandAll PRO" on page 29](#).

⇒ Scanned document images are displayed in the ScandAll PRO window.

2.2 Scanning Documents of Different Widths

When you scan documents of different widths at one time from the ADF, some documents that are small in paper size may be skewed or may not be fed into the scanner. It is recommended that only documents of the same width be scanned at one time.

In the case where you have to scan documents of different widths together, scan them, following the procedure below.

1. To prevent images from skewing, select [Automatic Page Size Detection] from the [Automatic Size and Skew Detection] drop-down list. (For details, refer to ["2.9 Correcting Skew" on page 71.](#))
2. Center all documents as shown in the figure below.

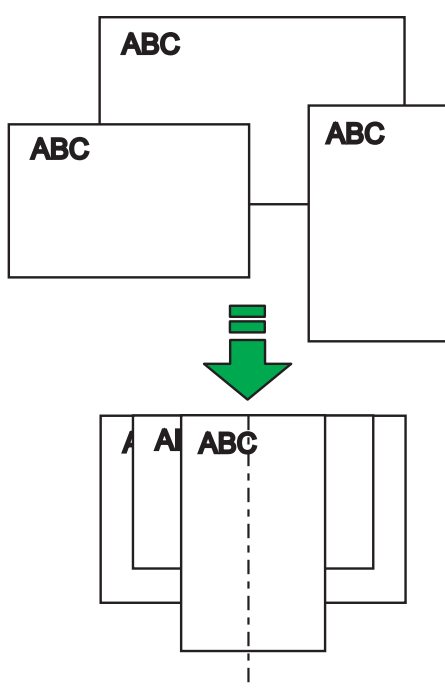

3. Place the documents on the ADF paper chute, and then adjust the side guides so that they lightly touch the widest sheets of paper.

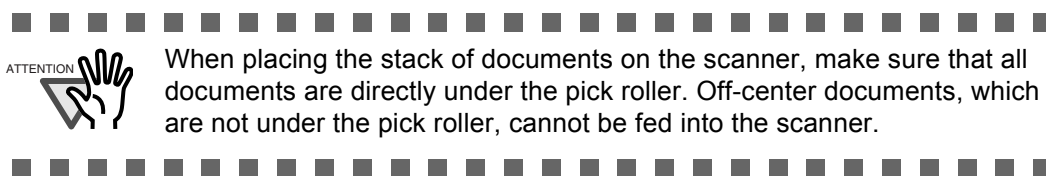

4. Scan the documents.

For information about how to scan documents, refer to section ["1.5 How to Use ScandAll PRO" on page 29.](#)

2.3 Scanning Thin Documents

When you scan a batch of thin documents (which are out of specifications with under 52g/m² of thickness), document jams (Multifeed) and mis-picking may occur. If you have to scan such documents, switch the lever to "Thin" side.

1. Make sure that the thin documents meet the requirements described in section ["6.2 Document Quality" on page 133](#).
2. Shift the position of the paper thickness switch to the "Thin" position (the factory default is "Normal" position).

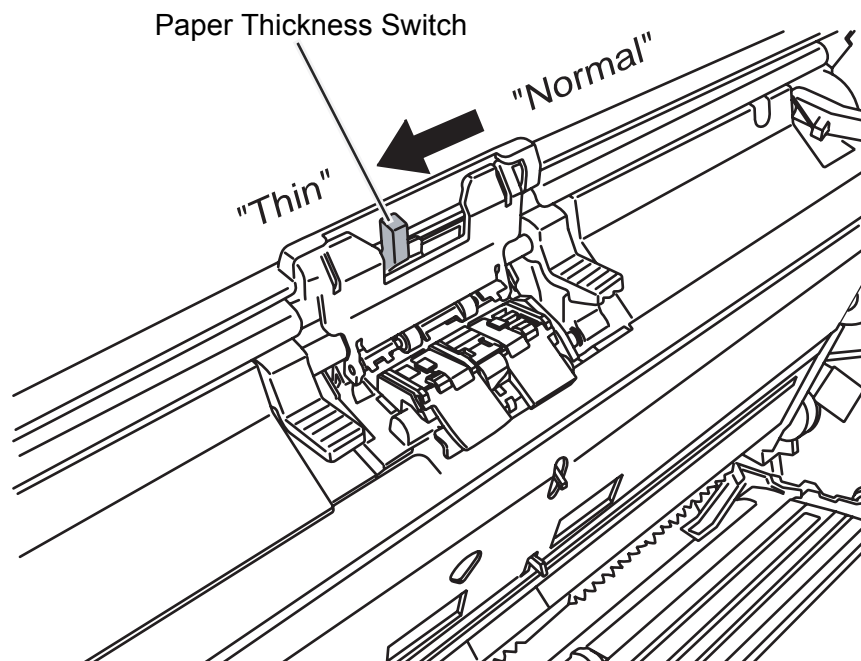

3. Scan the documents, following the procedure in section ["1.3 Scanning Documents" \(page 10\)](#).

For information about how to scan documents, refer to section ["1.5 How to Use ScandAll PRO" on page 29](#).



Move the Paper Thickness Switch to "Normal" position when scanning documents of standard thickness. Move the switch to "Thin" position only when you scan thin paper, which is of non-standard thickness (less than 52g/m²).

Note that feeding performance may be degraded when you scan documents of non-standard paper.



2.4 Scanning Documents Longer Than A3 Size

1. Place the document on the ADF.

For details, refer to "1.2 Placing Documents on the ADF" (page 6).

2. Launch ScandAll PRO.

From the [Start] menu, select [All Programs] ⇒ [Fujitsu ScandAll PRO] ⇒ [Fujitsu ScandAll PRO] in the order presented. ScandAll PRO starts up.

3. From the ScandAll PRO window, display the setup dialog box of FUJITSU TWAIN 32.

For information about how to display the setup dialog box of the scanner driver, refer to section "1.5 How to Use ScandAll PRO" on page 29.

4. Select [Long page (Front Side)] or [Long page (Duplex)] from the [Scan Type] drop-down list.

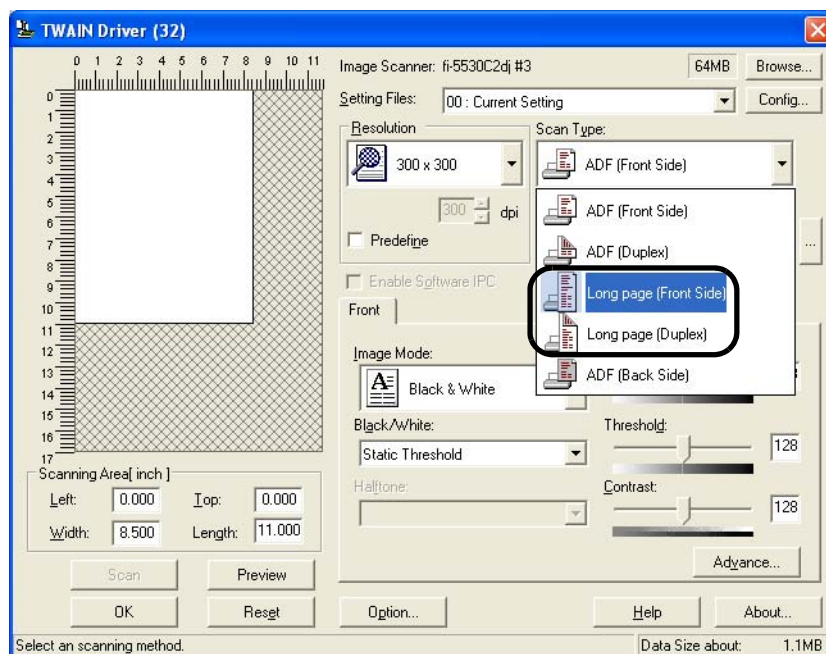

⇒ The [Long Page Paper Size Setting] dialog box appears.

5. Specify a document length, and then click the [OK] button.

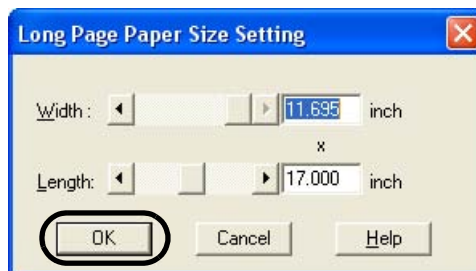

6. Click the [OK] button in the setup dialog box of FUJITSU TWAIN 32.

⇒ Changes made in this dialog box are saved and the setup dialog box closes.

7. Scan the document with ScandAll PRO.

For information about how to scan documents, refer to section "[1.5 How to Use ScandAll PRO](#)" on [page 29](#).

⇒ The document is scanned, and the scanned document image is displayed in the ScandAll PRO window.



The combined use of the following functions is not possible.

- Multi Image Output ([page 74](#))
- Auto Color Detection ([page 77](#))



2.5 Saving Scanned Images in PDF Format

To save scanned document images in PDF format, Adobe Acrobat must be installed on your computer.

Install Adobe Acrobat from the provided Adobe Acrobat CD-ROM.

You can create PDF files from the scanned document images by either of the following two ways:

1. From ScandAll PRO ([page 53](#))

Recommended for scanning in color or grayscale mode.

You can:

- Reduce the size of PDF files.
- Create PDF files with facility.

2. From Adobe Acrobat ([page 57](#))

Recommended when you want to create PDF files quickly and when you scan documents in black-and-white mode.

You can:

- Create PDF files at an original resolution in a short time.
- Create PDF files compressed to a desired size by changing compression rates.

The file size of color documents increases if scanned by following a general procedure. You can drastically reduce the size if you run Acrobat Distiller before saving. For details, refer to Hint on page 60.



Notes on the use of Adobe Acrobat

- Acrobat's default settings overrides the previous settings such as [Resolution], [Scan Type], and [Image Mode].
- The following functions cannot be used:
 - [256 Color] or [8 Color]
 - [Rotation Degree] when [End of Page Detection] is selected
 - Long Page Scanning
- When scanning a paper document and converting the scanned document image to PDF by using Acrobat, unexpected images may be output when:
 1. Setting [Edge Shadow Removal] in Acrobat, and setting [Digital Endorser] or [Black Background] options in the TWAIN driver at the same time. Character strings on images or part of background may be missed.

Solution 1: In Acrobat, select [File] - [Create PDF] - [From Scanner...] - [Image Settings...], and set [Edge shadow removal] to [OFF] or set [Color/Grayscale] and/or [Monochrome] under [Compression] to a setting other than [Adaptive].

Solution 2: Adjust the scanning density in the TWAIN driver.
 2. Setting [Color/Grayscale] and/or [Monochrome] to [Adaptive] under [Compression] in Acrobat and scanning documents in a resolution lower than the recommended resolution for Acrobat.

Solution: Set [Color/Grayscale] and/or [Monochrome] to a setting other than [Adaptive] under [Compression].
 3. Setting [Overscan] in the TWAIN driver because a document longer than the double letter (11x17) or A3 size cannot be loaded in Acrobat.

Solution: When scanning a double letter (11x17) or A3 size document, do not set [Overscan] in TWAIN driver.

For more information on Acrobat, including the use of Acrobat, refer to "Create a PDF file from a scanned document" in Acrobat Help.

■ From ScandAll PRO

1. Place the document on the ADF paper chute.

For details about how to scan documents, refer to section "[1.2 Placing Documents on the ADF](#)" on page 6.

2. Start up ScandAll PRO.

From the [Start] menu, select [All Programs] ⇒ [Fujitsu ScandAll PRO] ⇒ [Fujitsu ScandAll PRO] in the order presented. Then, ScandAll PRO starts up.

3. In ScandAll PRO, select [PDF File], [SinglePage PDF File], [PDF/A file], or [SinglePage PDF/A file] to save scanned document images.

When you want to perform [Scan] (⇒ [page 33](#))

In the [File Format] drop-down list, select one of the above settings.

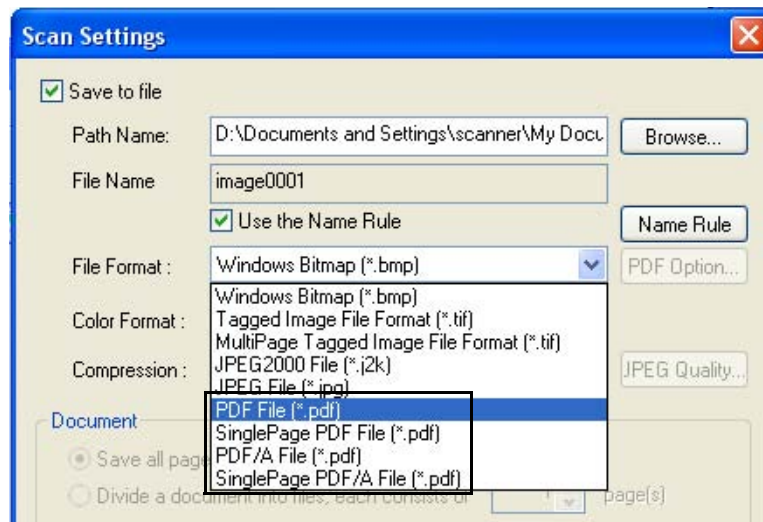

When you want to perform [Batch Scan] (⇒ [page 37](#))

Select a profile you want to use for scanning to display it in the [Profile Editor] dialog box. Select the [File format and Name scheme] tab, and then select one of the above settings from the [File Format] drop-down list.

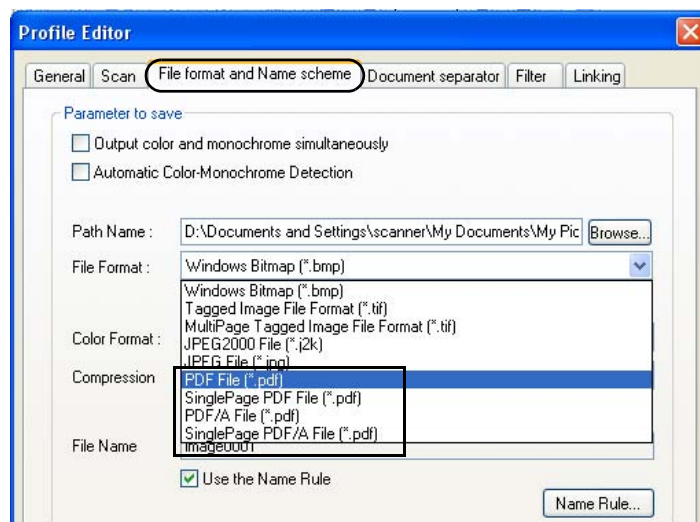



[PDF file] and [SinglePage PDF file] are saved in format compatible with Adobe Acrobat 4.0 (PDF 1.3); [PDF/A file] and [SinglePage PDF/A file] are saved in PDF/A-1b format (format for an archive of digital documents based on PDF 1.4).

[SinglePage PDF file] and [SinglePage PDF/A file] create one file per image; [PDF file] and [PDF/A file] create one file containing multiple images.

4. To configure PDF-related settings, click the [PDF Option] button ().

⇒ The [Output PDF file] dialog box appears.

In this dialog box, you can change the compression rate, turn on the OCR function (to make searchable PDF files), and enhance the security of created PDF files by adding a password to.

[Basic] Tab

Change the compression rate for creating PDF files from scanned document images.

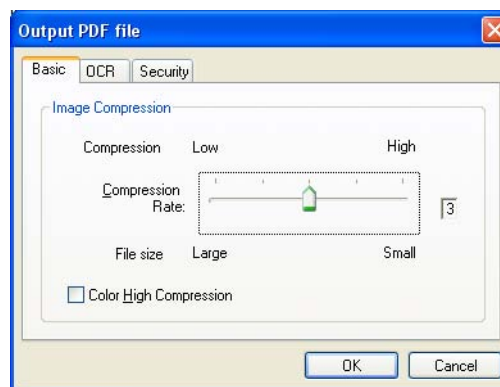

Compression Rate

Move the slider bar to change the compression rate.

The compression rate can be changed in five levels from 1 to 5. (By default, the compression rate is set to 3.)

Moving the slider bar to right increases the compression rate. Higher the compression rate, the smaller the file size, but the image quality is degraded.

This setting takes effect on color images only. When images are saved as monochrome images, this setting is ignored.

[Color High Compression] Checkbox

When this checkbox is marked, image portions in a color image are compressed at a higher rate separately from text. Therefore, when a document containing mostly text is scanned, the file size can be made smaller without causing text to become blurred. This setting is not suitable for scanning photographs and figures because the image quality of highly-compressed photographs and figures is degraded.

[OCR] Tab

You can configure settings so that PDF files are converted into searchable text when they are created from scanned document images.

Unless OCR (optical character recognition) is turned on, scanned document images are saved as PDF files in a format that computers cannot recognize, or in other words they are not made searchable. Through OCR, text on the image is recognized and text information is embedded into the image, making the image file searchable.

(Note that, if you turn on OCR, scanning takes time longer than if you do not.)

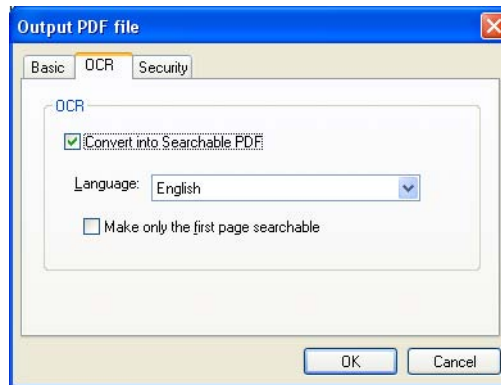
**[Convert into Searchable PDF] Checkbox**

The scanned document images are converted into searchable PDF files and saved.

Language

You can select a language to use for text recognition from the following: English, French, German, Italian, Japanese, Korean, Spanish, and Traditional/Simplified Chinese.

[Make only the first page searchable] Checkbox

When scanning a document containing multiple pages, you can make only the first page searchable. If this checkbox is marked, the time required is shorter than the time required for the conversion of all pages.

[Security] Tab

You can enhance security by setting a password for PDF files.

Once a password is added, you cannot open the PDF files unless you enter a correct password, which you type in in this dialog box.



[Add a Document Open Password to created PDF files] Checkbox

You can set a "Document Open" password to PDF files. Up to 16 characters (half-width) can be used for a password. This checkbox is available only for Adobe PDF files. (For PDF/A files, passwords cannot be set.)

If this checkbox is marked, the [Password] dialog box appears immediately after scanning.

Password-protected PDF files cannot be opened with ScandAll PRO. Open password-protected PDF files with Adobe Acrobat.

[Use a fixed password] Checkbox

If this checkbox is marked, all PDF files are protected with the fixed password you type in in this dialog box, so that the [Password] dialog box does not appear after scanning.

5. Scan the document with ScandAll PRO.

For information about how to scan documents, refer to section "[1.5 How to Use ScandAll PRO](#)" on page 29.

⇒ The scanned image is displayed.



ScandAll PRO creates PDF files from scanned document images but does not offer the function to open PDF files. You can open PDF files with ScandAll PRO anyway, but the displayed images may not be satisfactory or the operation of ScandAll PRO may become unstable.

To view PDF files, it is recommended an application that can open PDF files, such as Adobe Acrobat, be used.



■ Using Adobe Acrobat

1. Place the document on the ADF paper chute.
2. Launch Adobe Acrobat
 - From the [Start] menu, select [All Programs] - [Adobe Acrobat] in the order presented. Then, Adobe Acrobat starts up.
3. From the [File] menu, select [Create PDF], and then select [From Scanner].

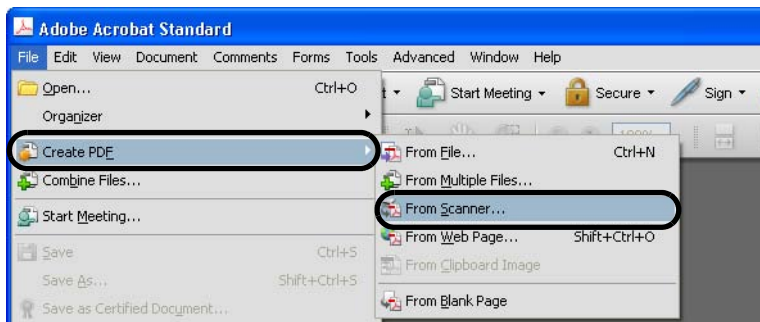

⇒ The [Acrobat Scan] dialog box appears.

4. Select [FUJITSU fi-5530C2dj] from the [Scanner] drop-down list.

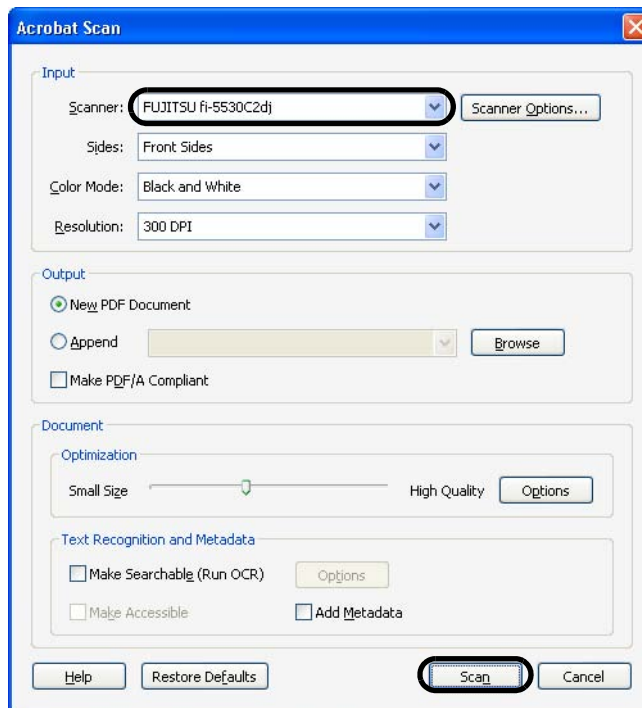



If scanned by using the default settings, images outputted may not be satisfactory. It is recommended the settings be changed, following the procedure below:

1. Clear the [Recognize Text Using OCR] checkbox.
2. Click the [Image Settings] button.
The [Image Settings] dialog box appears.
3. Change settings as follows:
 - Color/Grayscale: none
 - Monochrome: JBIG2 or CCITT Group 4
 - Background removal: Off
 - Edge shadow removal: Off

5. Click the [Scanner Options] button.

⇒ The [Scanner Options] dialog box appears.

6. If you want to change settings in the [TWAIN driver] dialog box as described in step 9, select [Show Scanner's Native Interface] from the [User Interface] drop-down list, and then click the [OK] button.

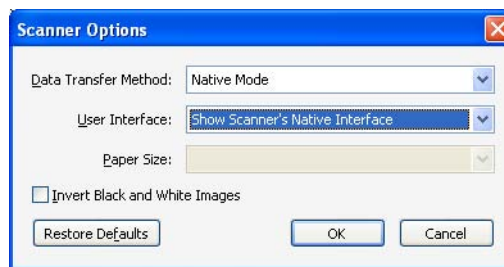

⇒ You will be returned to the [Acrobat Scan] dialog box.

7. Click the [Scan] button.

⇒ The [Save Scanned File As] dialog box appears.

8. Specify a destination (Save in) in which you want to save the scanned document image and its file name, and then click the [Save] button.

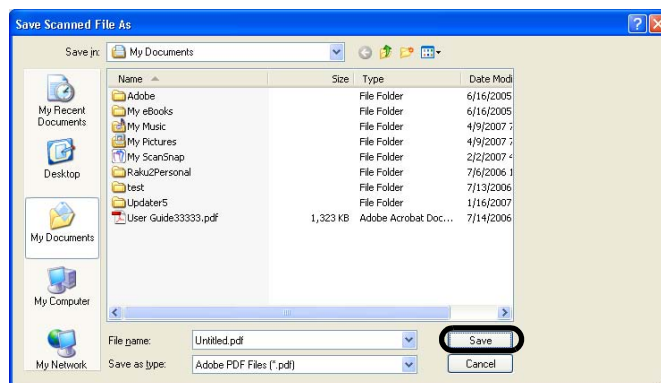

⇒ The [TWAIN driver] dialog box appears.

- Configure settings such as the scan resolution and document size, and then click the [Scan] button.

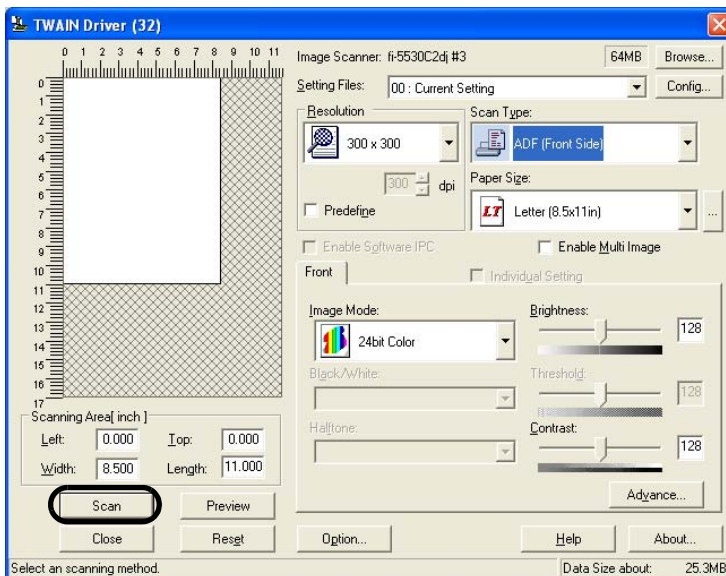

⇒ The document is scanned and another [Acrobat Scan] dialog box appears.

- To finish scanning, select the [Scanning complete] radio button, and then click the [OK] button.

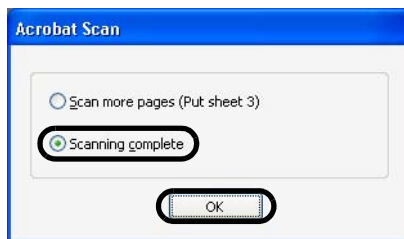

⇒ The scanned document image is saved to file and the image is displayed in the Adobe Acrobat window.

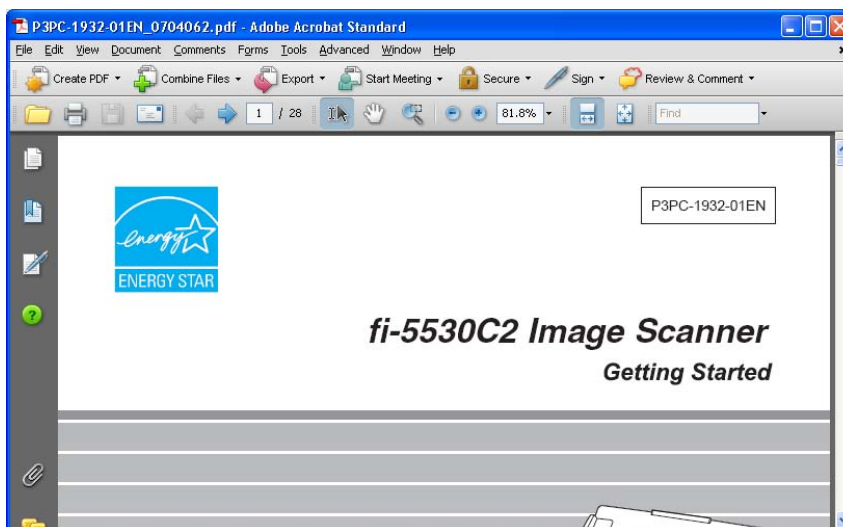

For details on the operation of Adobe Acrobat, refer to Adobe Acrobat Help.



If you save scanned document images as described above, the file size may increase greatly. To reduce the file size, save images following the procedure below. (It may take time than you save as described above.)

1. Select [File] - [Print]
2. In the dialog box below, select [Adobe PDF] from the [Name] drop-down list.

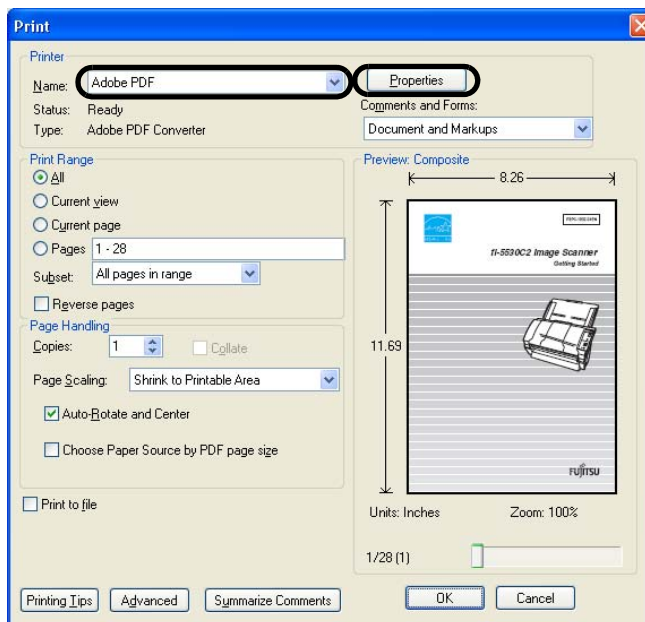

3. Click the [Properties] button.
4. Select the [Adobe PDF Settings] tab.
5. Select a desired setting from the [Default Settings] drop-down list. The following shows an example when [Smallest File Size] is selected.

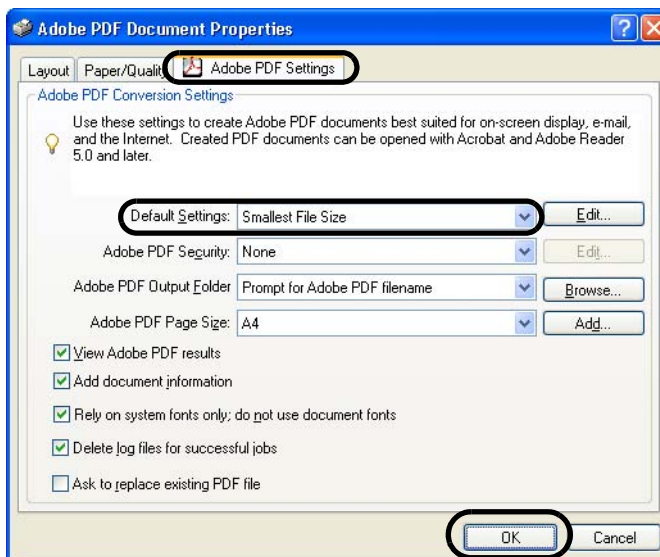

6. Click the [OK] button.
7. Click the [OK] button in the [Print] dialog box.
8. Enter a file name, and then click the [Save] button in the [Save PDF File As] dialog box.



2.6 Excluding a Color from Images (Dropout Color)

You can select a color from primary colors (red, green, and blue) to remove (drop out) from a scanned document image. For example, when you scan a document containing black text with green background, you can output an image of only black text.

Enable the dropout color setting in the setup dialog box of the scanner driver.

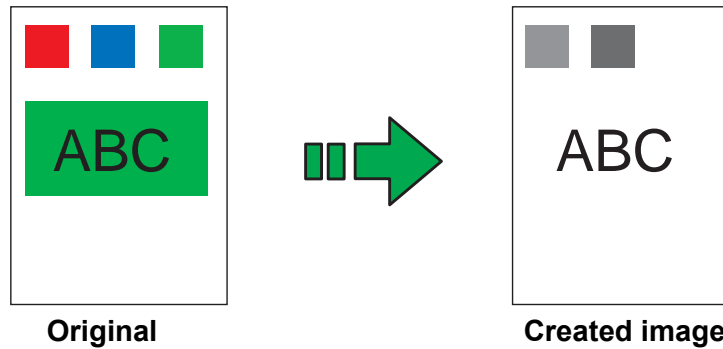

Example: When green is selected as a dropout color

The following shows the procedure to change settings in the setup dialog box of FUJITSU TWAIN 32 Scanner Driver.

1. From ScandAll PRO, display the setup dialog box of FUJITSU TWAIN 32.
For information about how to display the setup dialog box of the scanner driver, refer to section "1.5 How to Use ScandAll PRO" on page 29.
2. In the TWAIN Driver dialog box, click the [Advance] button.

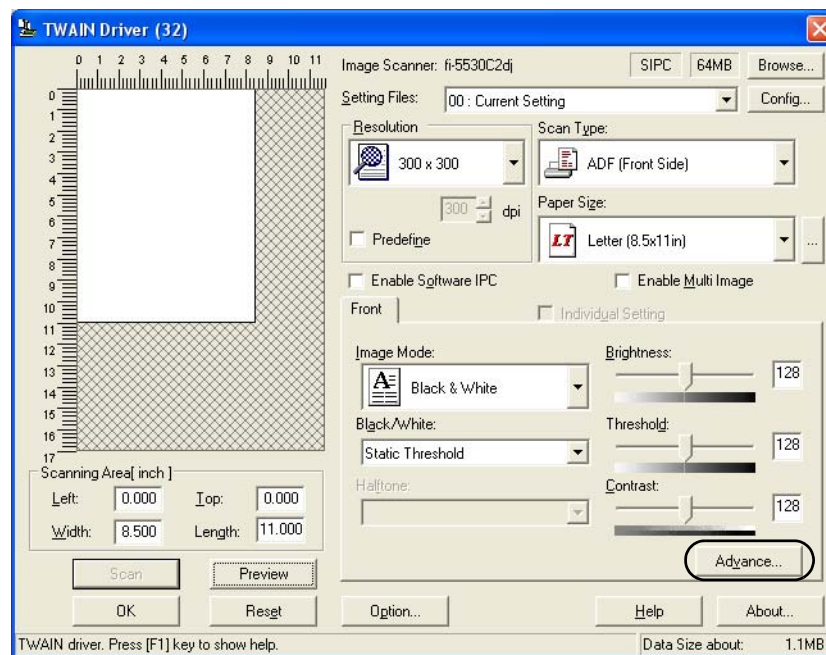

⇒ The [Advance] dialog box appears.

3. Select a color you want to remove, from the [Dropout Color] drop-down list under [More].

For example, when you want to obtain only black text image from a document containing black text outlined in green, select [Green] from the list.

If you want no color to be dropped out, select [None].

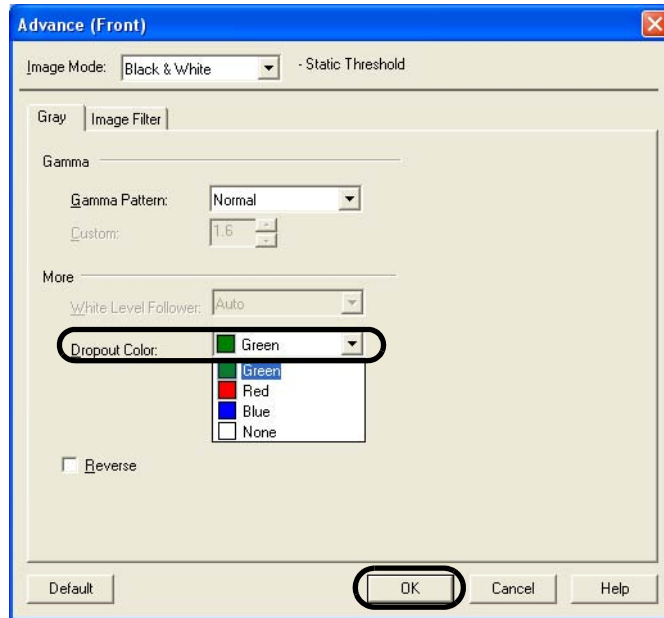

4. Click the [OK] button.
 - ⇒ You are returned to the [TWAIN Driver] dialog box.
5. In the [TWAIN Driver] dialog box, click the [OK] button.
 - ⇒ Changes made are saved and the [TWAIN Driver] dialog box closes.

Continue scanning in ScandAll PRO.

For information about how to scan documents, refer to section ["1.5 How to Use ScandAll PRO" on page 29](#).

2.7 Skipping Blank Pages

Blank pages in a document are detected and removed automatically. For example, when scanning both double-sided and single-sided documents together in duplex mode, you can obtain the scanned document images without blank pages. Configure the setting in the setup dialog box of the scanner driver.

1. From ScandAll PRO, display the setup dialog box of FUJITSU TWAIN 32.
For information about how to display the setup dialog box of the scanner driver, refer to section "1.5 How to Use ScandAll PRO" on page 29.
2. In the TWAIN Driver dialog box, click the [Option] button.

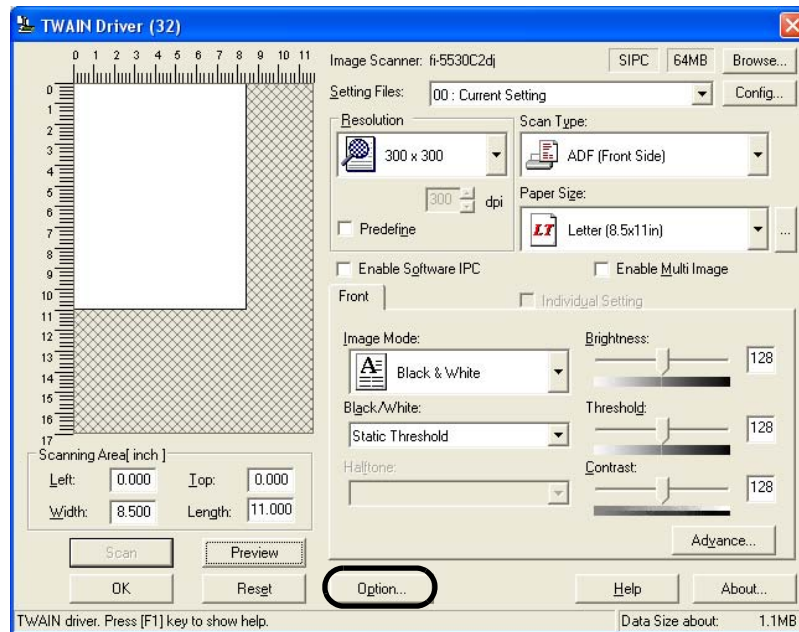

⇒ The [Option] dialog box appears.

3. Select the [Job/Cache] tab.
4. Mark the [Blank Page Skip] checkbox.

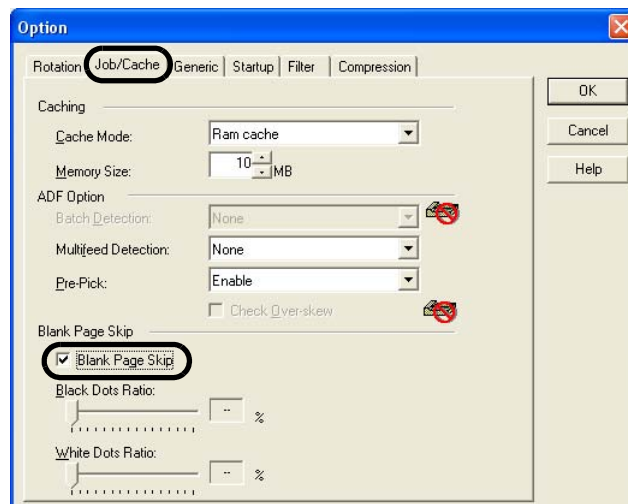

If this checkbox is marked, cache mode is automatically changed to [Ram cache].

5. With the slider control under [Blank Page Skip], specify the Blank Page Skip degree.

<In Binary/Halftone mode>

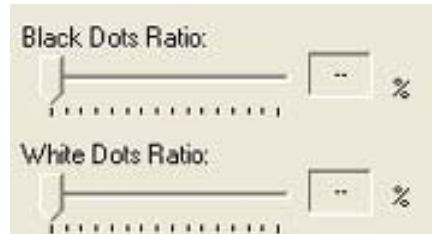

For white pages, use the [Black Dots Ratio] slider bar to specify a degree of accuracy needed to skip blank pages. For black pages, use the [White Dots Ratio] scroll bar to specify a degree of accuracy needed to skip blank pages.

The value displayed to the right of the slider bar shows a noise (dots) ratio(*1). If a scanned page includes dots less than this value, the page is recognized as blank. You can select OFF(-) or a value from 0.2% to 3.0% (in increments of 0.2%).

*1: Ratio of black dots included in a scanned area. (for white pages)

<In Color/Grayscale mode>



Use the slider bar to specify a level in five levels from 1 to 5. The larger the number, the higher the accuracy.

6. Click the [OK] button.
 - ⇒ You are returned to the [TWAIN Driver] dialog box.
7. In the [TWAIN Driver] dialog box, click the [OK] button.
 - ⇒ Changes made are saved and the [TWAIN Driver] dialog box closes.

Continue scanning in ScandAll PRO.

For information about how to scan documents, refer to section "[1.5 How to Use ScandAll PRO](#)" on page 29.

2.8 Detecting Multifeeds

"Multifeed" is an error that occurs when two or more sheets are accidentally fed into the ADF at the same time. By changing a setting, you can receive an error message when the scanner detects a multifeed.

To enable multifeed detection, change the setting in the setup dialog box of a scanner driver.

The following shows the procedure to change settings in FUJITSU TWAIN 32 Scanner Driver.

1. From ScandAll PRO, display the setup dialog box of FUJITSU TWAIN 32.
For information about how to display the setup dialog box of the scanner driver, refer to section "1.5 How to Use ScandAll PRO" on page 29.
2. In the TWAIN Driver dialog box, click the [Option] button.

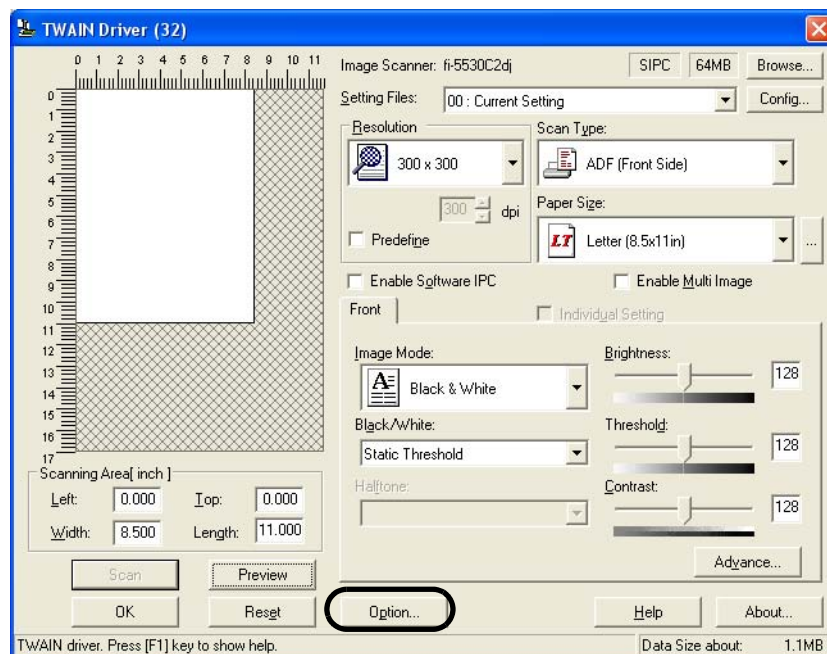

⇒ The [Option] dialog box appears.

3. Select the [Job/Cache] tab.

- Select how to detect multifeeds from the [Multifeed Detection] drop-down list under [ADF Option].

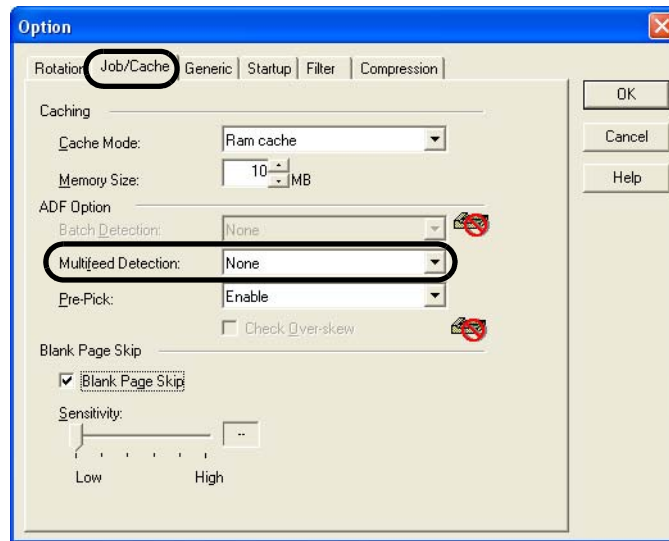

The following are how to detect multifeeds:

- None** : Multifeed detection is not performed
- Check overlapping** : The scanner monitors the thickness of fed documents. The scanner detects a multifeed based on an increased thickness when multiple sheets are fed simultaneously.
- Check length** : The scanner monitors the length of fed documents. The scanner detects a multifeed based on an increased length when multiple sheets are fed simultaneously.
- Check overlapping and length** : The scanner monitors both document thickness and length to detect multifeeds.

For more information on multifeed detection, refer to ["6.5 Specifying How to Detect Multifeed" on page 139](#).

- Click the [OK] button.
⇒ You are returned to the [TWAIN Driver] dialog box.
- In the [TWAIN Driver] dialog box, click the [OK] button.
⇒ Changes made are saved and the [TWAIN Driver] dialog box closes.

Continue scanning in ScandAll PRO.

For information about how to scan documents, refer to section ["1.5 How to Use ScandAll PRO" on page 29](#).

■ To Specify the Area for Multifeed Detection

Normally, the multifeed detection function monitors paper overlaps at the central part of sheets (width: 35mm). Therefore, some types of documents, such as the resume and postcard, on which a photograph or stamp is pasted, may be accidentally recognized as multifeed documents.

When scanning these types of documents, you can prevent multifeed errors by narrowing down the area to be detected. Enable this function, following the procedure below.

1. Open the Scanner's Properties dialog box.
 - 1) Turn on your scanner, and then check that the scanner is connected to a personal computer. For information about how to connect the scanner to your personal computer, refer to "2.2 Connecting the Scanner to a PC" in fi-5530C2 Getting Started on the CD-ROM.
 - 2) Double-click on the [Printer and Other Hardware] icon in Control Panel.

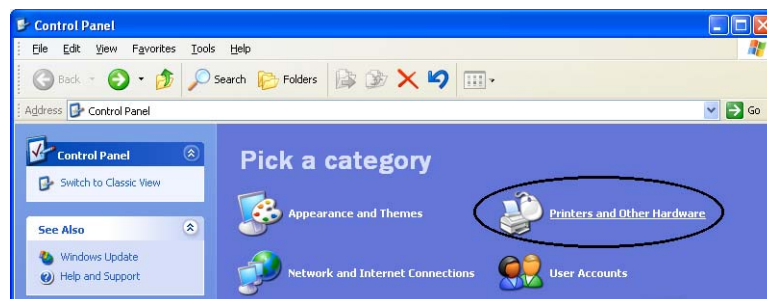

⇒ The [Printer and Other Hardware] window appears.

- 3) In the [Printers and Other Hardware] window, double-click on the [Scanners and Cameras] icon.

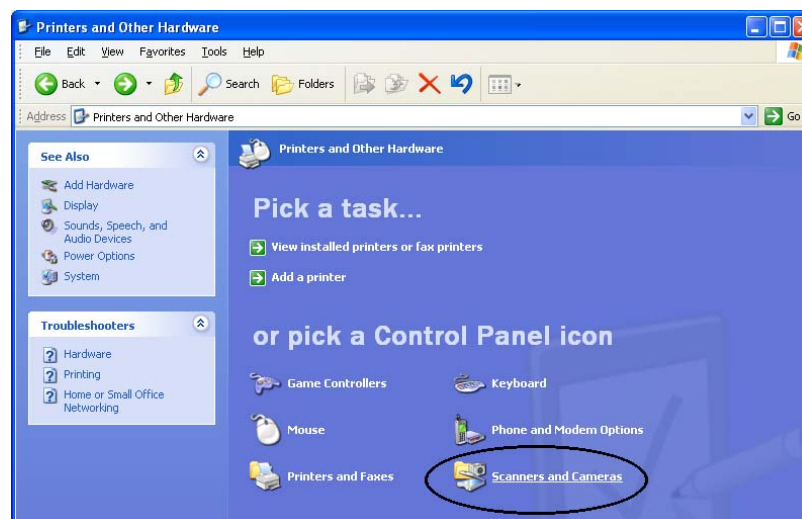

⇒ The [Scanners and Cameras] window is displayed.

- 4) Right-click on the [fi-5530C2dj] icon (in Windows XP/Windows Server 2003), or double-click on it (in Windows 2000/Windows Vista), and then select [Properties] from the pop-up menu.



⇒ The [fi-5530C2dj Properties] dialog box appears.

- 5) Select the [Device Set] tab.

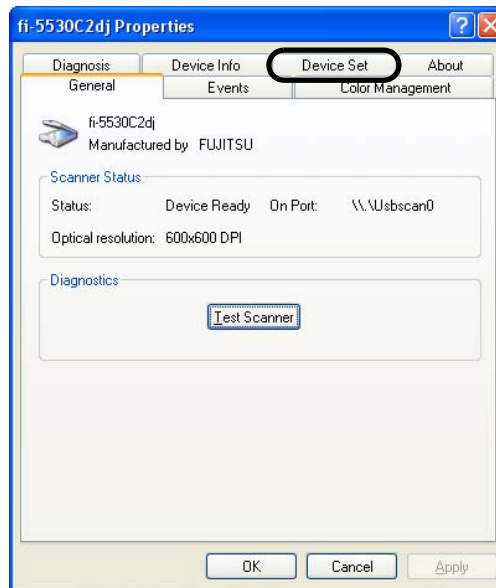

⇒ The following dialog box appears.

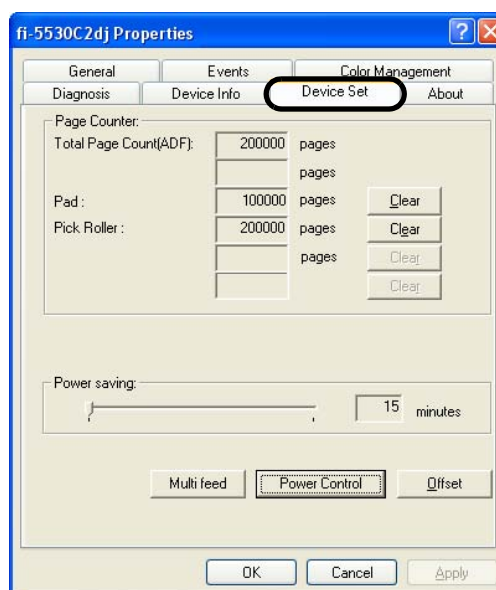

2. Click the [Multifeed] button.

⇒ The following dialog box appears.

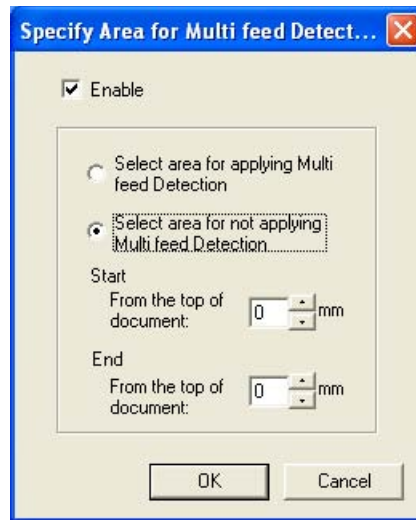

3. Configure settings in the [Specify Area for Multifeed Detection] dialog box.

1) Mark the [Enable] check box.



- You can specify an area in the direction of the length of the document for detecting multifeed errors.
- Unless the [Enable] checkbox is marked, the area of [Select area for applying Multifeed Detection] or [Select area for not applying Multifeed Detection] cannot be specified. In this case, normal multifeed detection described above is performed. (Refer to ["6.5 Specifying How to Detect Multifeed" on page 139.](#))

2) Select whether you want to specify an area to enable or disable multifeed detection.

- To specify an area for which the Multifeed Detection is performed:
⇒ Select the [Select area for applying Multifeed Detection] button.
- To specify an area for which the Multifeed Detection is NOT performed:
⇒ Select the [Select area for not applying Multifeed Detection] radio button.

3) Specify the [Start] position in the area.

Enter a distance from the top of the document as a starting position in millimeter.
(Select an even number from 0 mm to 510 mm)

4) Specify the [End] position in the area.

Enter a distance from the the top of the document. (Select an even number from 0 mm to 510 mm)



The number you enter as the [End] position must be larger than that of the [Start] position.

2.9 Correcting Skew

The skew of documents can be detected and corrected automatically by enabling the automatic deskew function.

Change the setting in the setup dialog box of the scanner driver.

The following shows the procedure to change settings in the setup dialog box of FUJITSU TWAIN 32 Scanner Driver.

1. From ScandAll PRO, display the setup dialog box of FUJITSU TWAIN 32.
For information about how to display the setup dialog box of the scanner driver, refer to "[1.5 How to Use ScandAll PRO](#)" on page 29.
2. In the TWAIN Driver dialog box, click the [Option] button.

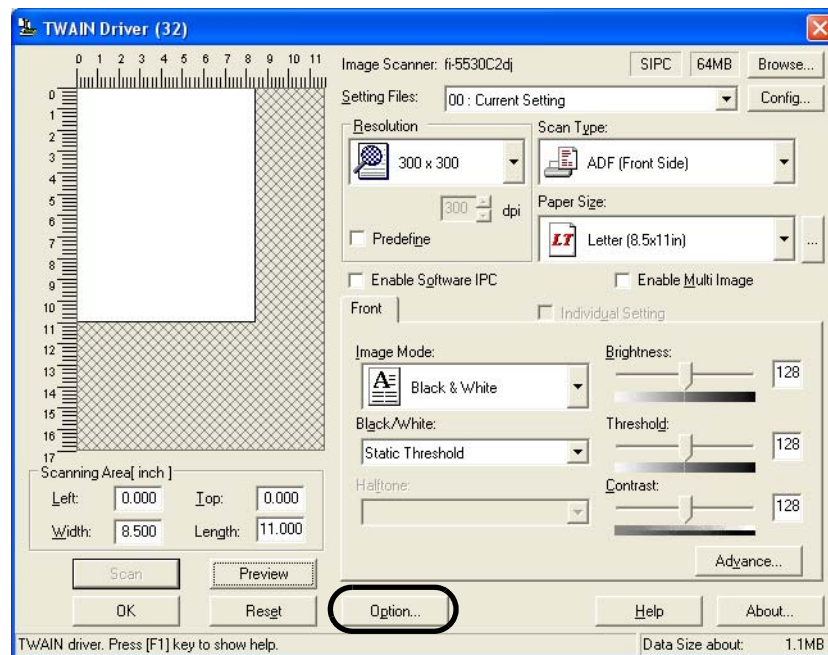

⇒ The [Option] dialog box appears.

3. Select the [Rotation] tab.

- Select [Automatic Page Size Detection] from the [Automatic Size and Skew Detection] drop-down list.

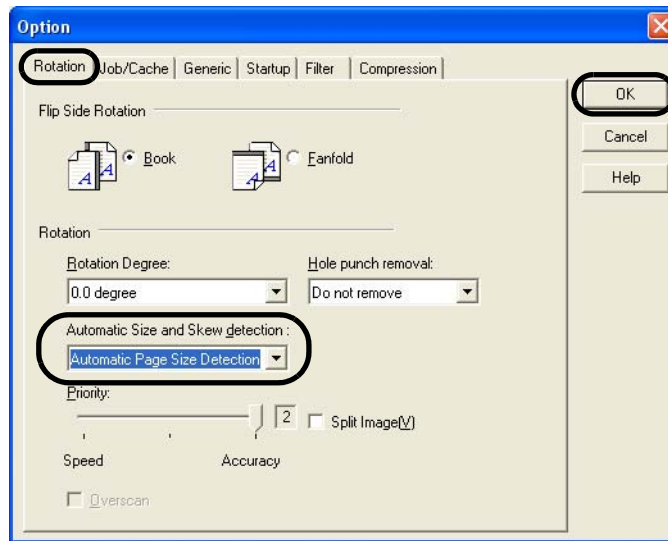

With the [Priority] slider control, you can change the accuracy of Automatic Page Size Detection.

- Move the slider to right to improve the detection accuracy. Note that the higher the accuracy, the longer the processing time, and the scanning speed becomes slower.
- When detecting paper sizes of index sheets or documents to which sticky notes or index tabs are attached, set the Priority to 2.

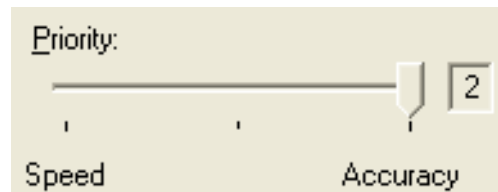

If one of the following conditions is met, the Automatic Page Size Detection may not work properly.

1. Paper is 52g/m² or less in weight
2. Documents are not rectangular
3. The margin of pages is filled with dark color

- Click the [OK] button.

⇒ You are returned to the [TWAIN Driver] dialog box.

- In the [TWAIN Driver] dialog box, click the [OK] button.

⇒ Changes made are saved and the [TWAIN Driver] dialog box closes.

Continue scanning in ScandAll PRO.

For information about how to scan documents, refer to section "[1.5 How to Use ScandAll PRO](#)" on page 29.

2.10 To Output Multi-Images

You can obtain both color/grayscale and black-and-white images at a scan (Multi Image Output).

* Depending on the application to use, this function may not work properly.
Configure Multi Image settings using the scanner driver.

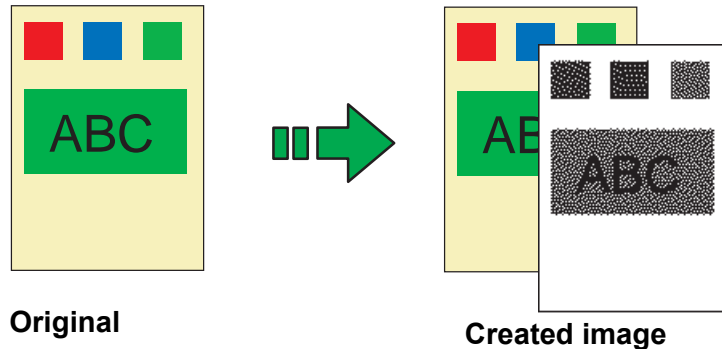

Original

Created image

Example: When the color document is scanned with Multi Image Output being set

The following shows the procedure to change settings in the setup dialog box of FUJITSU TWAIN 32 Scanner Driver.

1. From ScandAll PRO, display the setup dialog box of FUJITSU TWAIN 32.

For information about how to display the setup dialog box of the scanner driver, refer to "[1.5 How to Use ScandAll PRO](#)" on page 29.

2. In the TWAIN Driver dialog box, mark the [Enable Multi Image] checkbox.

* When you select [Long page] under [Scan Type], this checkbox is not available.

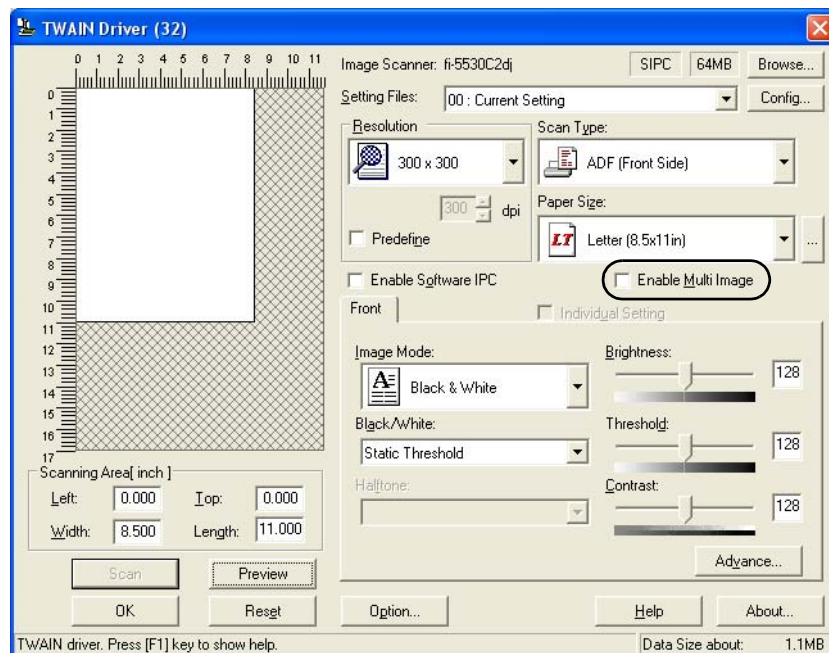

6. In the [TWAIN Driver] dialog box, click the [OK] button.

⇒ Changes made are saved and the [TWAIN Driver] dialog box closes.

Continue scanning in ScandAll PRO.

For information about how to scan documents, refer to section "[1.5 How to Use ScandAll PRO](#)" on page 29.

2.11 Color/Monochrome Auto Detection

This scanner features automatic detection of color or black-and-white document scans (the term "scan," in this case, refers to a produced image by scanning).

Scanning color documents produces color (or grayscale) images, and scanning black-and-white documents produces black-and-white images.

* Depending on the application to use, this function may not work properly.

Configure Multi Image settings using the scanner driver.

The following shows the procedure to change settings in the setup dialog box of FUJITSU TWAIN 32 Scanner Driver.

1. From ScandAll PRO, display the setup dialog box of FUJITSU TWAIN 32.

For information about how to display the setup dialog box of the scanner driver, refer to section "1.5 How to Use ScandAll PRO" on page 29.

2. In the TWAIN Driver dialog box, mark the [Enable Multi Image] checkbox.

* When you select [Long page] under [Scan Type], this checkbox is not available.

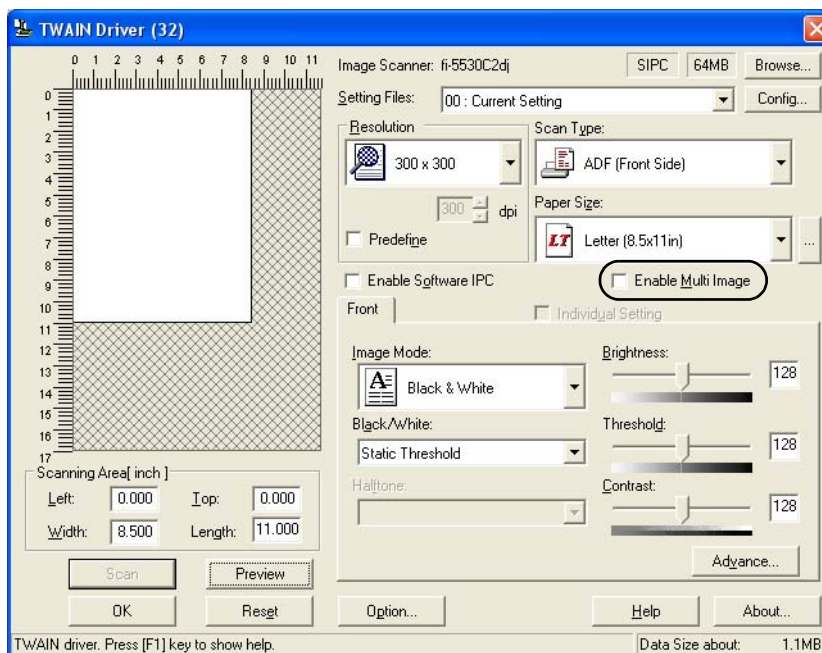

2.12 Splitting a Page in Two Pages

You can obtain two images by horizontally splitting a scanned page image.

* Depending on the application to use, this function may not work properly.

Enable the Split Image function in the setup dialog box of the scanner driver.

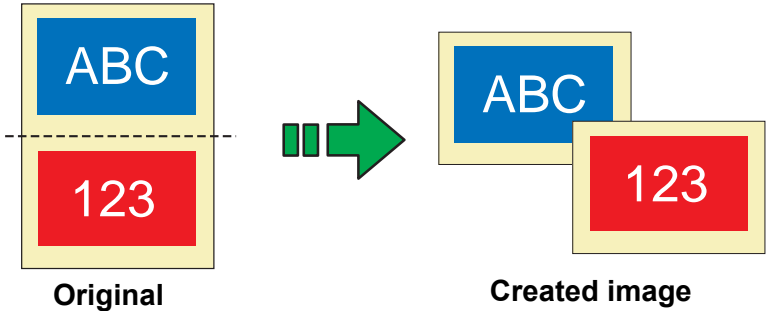

The following shows the procedure to change settings in the setup dialog box of FUJITSU TWAIN 32 Scanner Driver.

1. From ScandAll PRO, display the setup dialog box of FUJITSU TWAIN 32.
For information about how to display the setup dialog box of the scanner driver, refer to section "1.5 How to Use ScandAll PRO" on page 29.
2. In the TWAIN Driver dialog box, mark the [Option] checkbox.

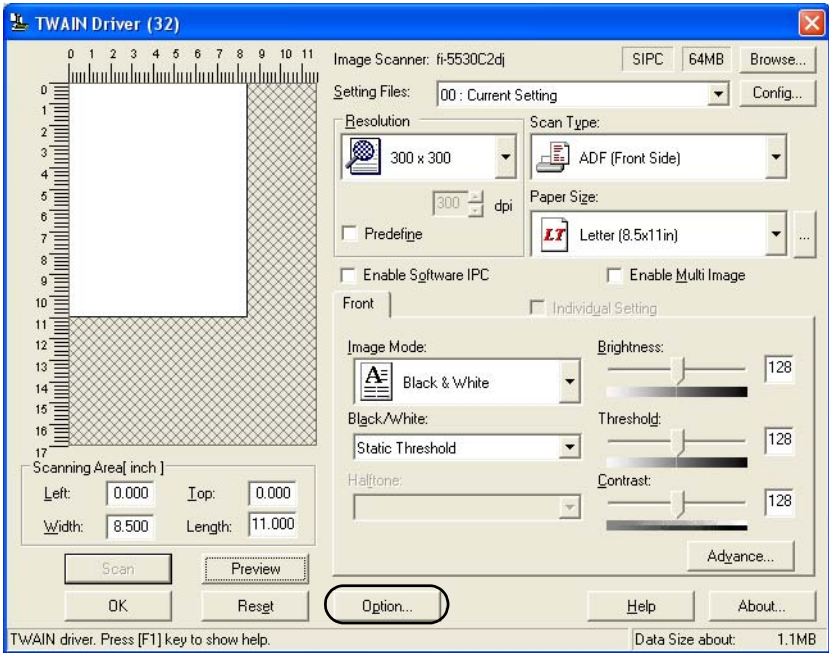

⇒ The [Option] dialog box appears.

3. Select the [Rotation] tab.

4. Mark the [Split Image] checkbox.

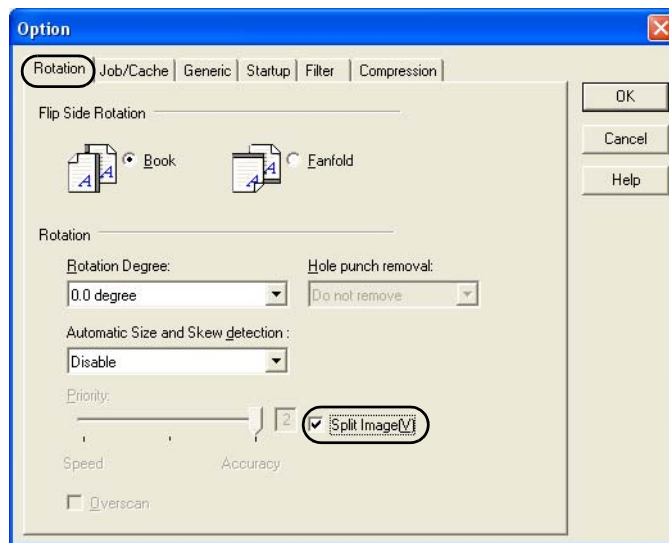

HINT

When a double-sided document is scanned in Duplex mode, the scanned document image is output according to the [Flip Side Rotation] setting in the order presented below:

- Book: Upper half ⇒ Lower half
- Fanfold: Lower half ⇒ Upper half



ATTENTION

If one of the following settings is set, this function is not available.

1. Multi Image Output ([page 74](#))
2. Color/Monochrome Auto Detection ([page 77](#))
3. The resolution is set to 1200dpi

5. Click the [OK] button.

⇒ You are returned to the [TWAIN Driver] dialog box.

6. In the [TWAIN Driver] dialog box, click the [OK] button.

⇒ Changes made are saved and the [TWAIN Driver] dialog box closes.

Continue scanning in ScandAll PRO.

For information about how to scan documents, refer to section "[1.5 How to Use ScandAll PRO](#)" on [page 29](#).

2.13 Removing Punch Holes from Images

You can remove (obscure) punch holes (black dots) from scanned document images when scanning punched documents.

Configure the Hole Punch Removal settings using the scanner driver.

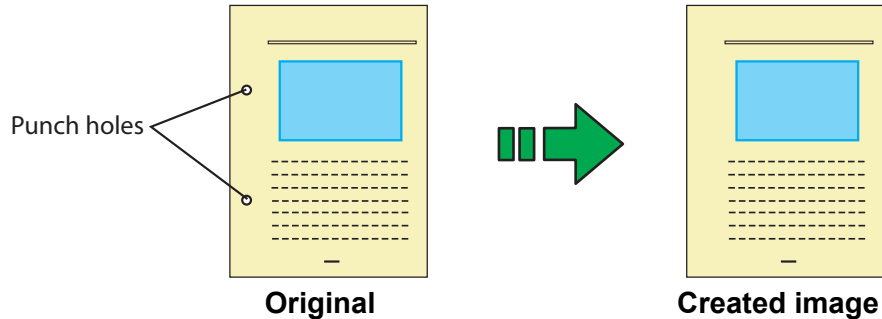

The following shows the procedure to change settings in the setup dialog box of FUJITSU TWAIN 32 Scanner Driver.

1. From ScandAll PRO, display the setup dialog box of FUJITSU TWAIN 32.

For information about how to display the setup dialog box of the scanner driver, refer to section "1.5 How to Use ScandAll PRO" on page 29.

2. In the TWAIN Driver dialog box, click the [Option] button.

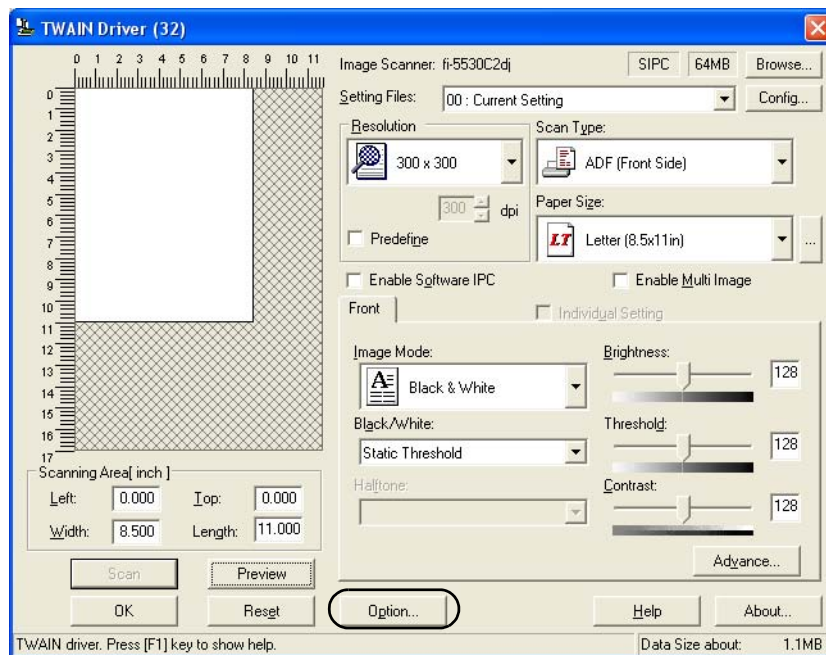

⇒ The [Option] dialog box appears.

3. Select the [Rotation] tab.

4. Select [Automatic Page Size Detection] or [Black Background] from the [Automatic Size and Skew detection] drop-down list.

If you select a setting other than [Automatic Page Size Detection] or [Black Background], [Hole Punch Removal] is not available.

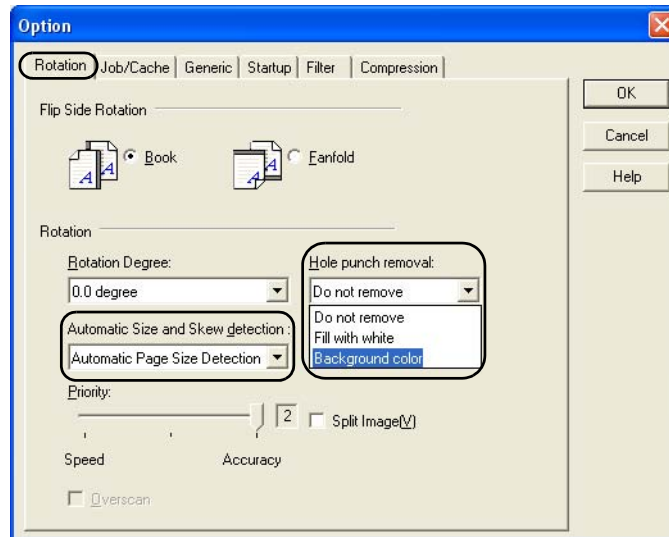

5. Select [Fill with white] or [Background color] from the [Hole punch removal] drop-down list.

Fill with white: Punch hole marks are filled with white

Background color: Punch hole marks are filled with a color most used around the holes.

When scanning a color document, select [Background color]. If you select [Fill with white], punch holes will be filled with white.

6. Click the [OK] button.
⇒ You are returned to the [TWAIN Driver] dialog box.
7. In the [TWAIN Driver] dialog box, click the [OK] button.
⇒ Changes made are saved and the [TWAIN Driver] dialog box closes.

Continue scanning in ScandAll PRO.

For information about how to scan documents, refer to section ["1.5 How to Use ScandAll PRO" on page 29](#).



Punch hole marks cannot be removed when:

- Hole marks are not aligned along with the edge of the document.
- Hole mark sizes vary or hole marks appear at various intervals.
- The document is not rectangular.
- The document of dark-colored background is scanned.
- Characters or figures exist at the edge of the document, or characters or figures overlap with hole marks.
- With [Automatic Page Size Detection] enabled, the document of a size larger than the specified page size is scanned.
- With [Black Background] selected, the document of a different size from the specified page size is scanned.



2.14 Scanning by Pressing the Scan Button on the Scanner

With ScandAll PRO, you can perform batch scan at a press of the button, by assigning a Batch Scan profile to the [Scan] or [Send to] button.

The following shows the procedure to do so.

1. From the [Start] menu, select [Control Panel].
2. Select [Scanners and Cameras].
3. Display the [fi-5530C2dj Properties] dialog box.

In Windows XP or Windows Server 2003, right-click on the [fi-5330C2dj] icon. In Windows 2000 or Windows Vista, double-click on the [fi-5330C2dj] icon.

4. Select the [Events] tab.
5. Select a button to use for an event.

In Windows XP, from the [Select an event] drop-down list, select an event to launch the application.

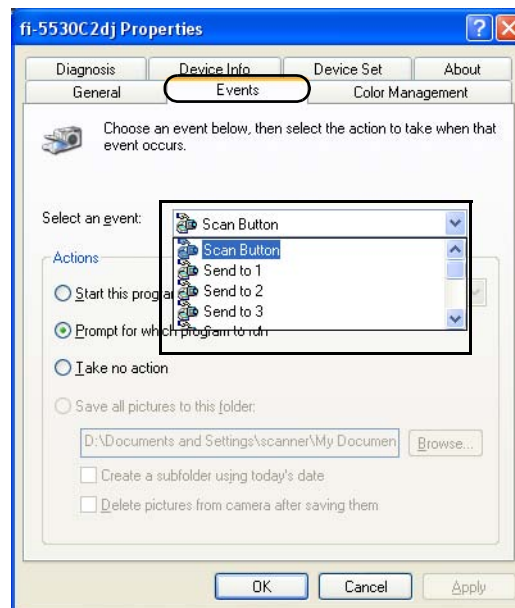

The following events can be selected:

- Scan Button (Press the [Scan] button)
- Send to 1 to 9 (With a number from 1 to 9 displayed on the Function Number Display, press the [Send to] button)

11. Click the action of the Event you selected in step 5, and then select a profile from the list you want to use for scanning.

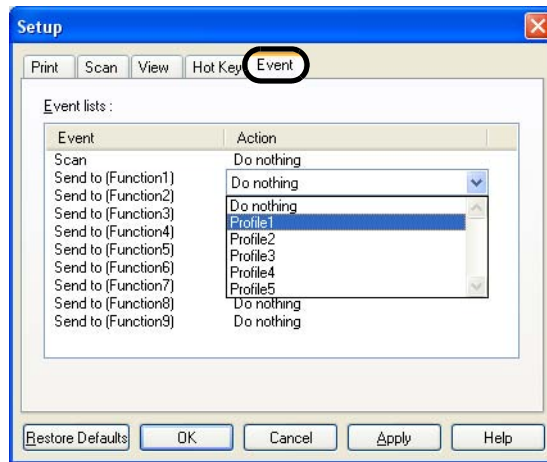

You have to create profiles beforehand.
For information about how to create profiles, refer to "Batch Scan" (page 37) in section "1.5 How to Use ScandAll PRO" on page 29.

12. Click the [OK] button.

13. Exit ScandAll PRO.

⇒ When you press the linked button, ScandAll PRO starts up, and batch scan is executed according to the selected profile's settings.



Use the [Send to] button, following the procedure below:

1. Press the [Function] button, and change a number displayed on the Function Number Display.
2. When the displayed number and the event number you have selected in step 5 (Send to 1 - 9) matches, stop pressing the [Function] button.
3. Press the [Send to] button.

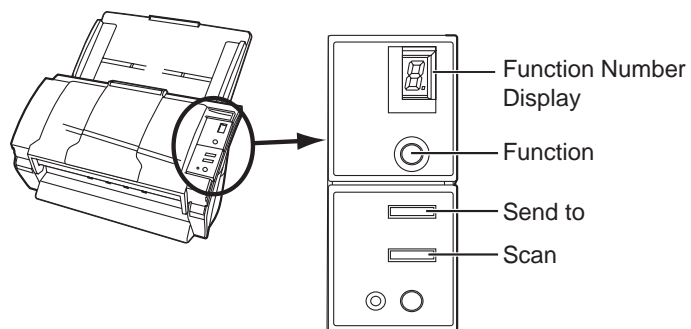

Chapter 3

DAILY CARE

This chapter describes how to clean the scanner.



The glass surface inside the ADF becomes hot during the operation of the scanner. Before you start cleaning the inner parts of the scanner, disconnect the AC adapter from the power outlet, and wait at least 15 minutes.

Do not turn off the scanner when you clean the Feed and Eject Rollers.

3.1 Cleaning Materials and Locations requiring Cleaning	88
3.2 Cleaning the ADF	90

3.1 Cleaning Materials and Locations requiring Cleaning

■ Cleaning Materials

Cleaning Materials	Parts Number	Remarks
Cleaner F1 	PA03950-0352 (*1)	1 bottle Moisten a cloth with this fluid and wipe the scanner clean.
Lint-free dry cloth	- Commercially available one	

For details about the cleaning materials, contact the FUJITSU scanner dealer where you purchased the scanner.

*1) It may take long before the cleaner vaporizes if a large quantity is used. When cleaning the scanner parts, dampen a cloth with modest quantities of the cleaner. In addition, wipe off the cleaner completely with a soft lint-free cloth to leave no residue on the surface of the cleaned parts.

■ Locations and Cycle for Cleaning

The following table shows a standard cycle provided as a guide for cleaning each location.

Part to clean	Standard Cleaning Cycle
Pad ASSY	Clean these parts after every 5,000 scans.
Pick roller	
Feed rollers	
Plastic rollers	
Eject rollers	
Sheet guides	
Glass	
Ultra sonic sensor	



The scanner must be cleaned more frequently if you scan any of the following type of sheets:

- Documents of coated paper
- Documents containing printed text or graphics all over the page
- Chemically treated documents such as carbonless paper
- Documents containing a large amount of calcium carbonate
- A large volume of documents written with pencil
- Documents on which the toner is not fused sufficiently

3.2 Cleaning the ADF

As a guideline, clean the ADF after every 5,000 scans. Note that this guideline varies according to the type of documents you scan. For example, it may be necessary to clean the ADF more frequently when you scan documents on which the toner is not firmly fixed on.



The glass surface inside the ADF becomes hot during the operation of the scanner. Before you start to clean the inner parts of the scanner, disconnect the AC adapter from the power outlet, and wait at least 15 minutes.

Do not turn off the scanner when you clean the Feed and Eject Rollers.

■ Cleaning Method

1. Open the ADF while pushing down the ADF button.

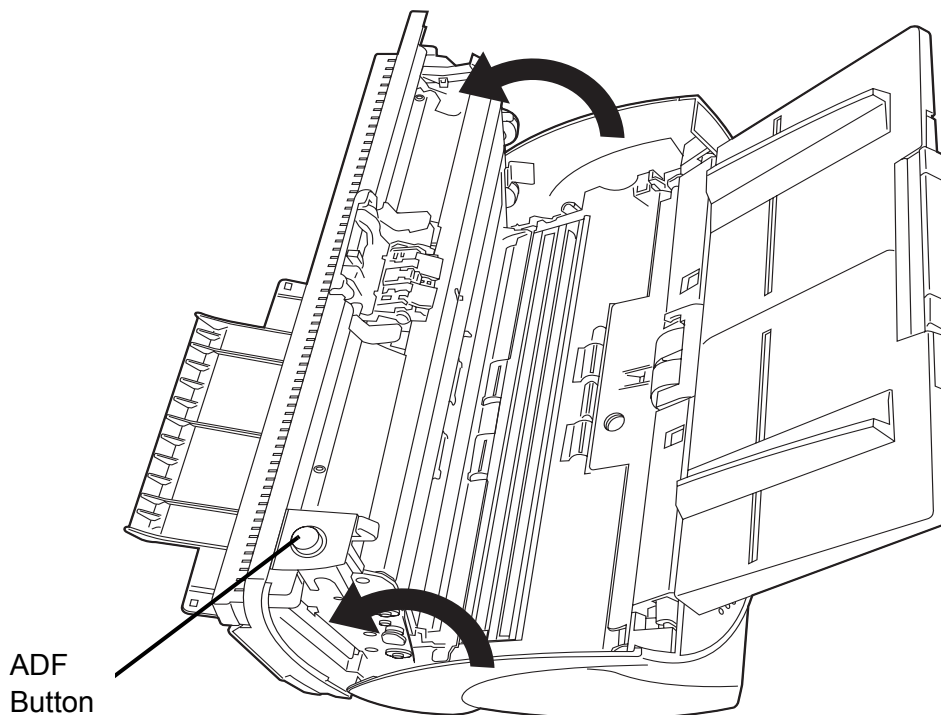

Be careful, the ADF cover may close suddenly and pinch your fingers.

-
- Pad ASSY
Clean the Pad ASSY (rubber surface) downward (in the direction of the arrow).

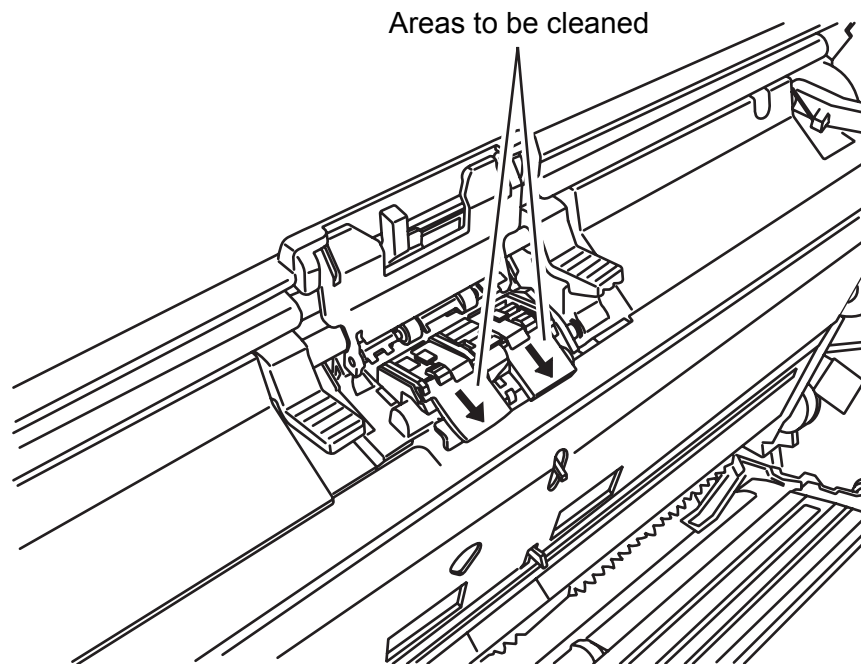

- Pick rollers
Clean the Pick rollers lightly preventing scratches on the rollers' surface. Take particular care in cleaning these rollers as black debris on them adversely affects the pickup performance.

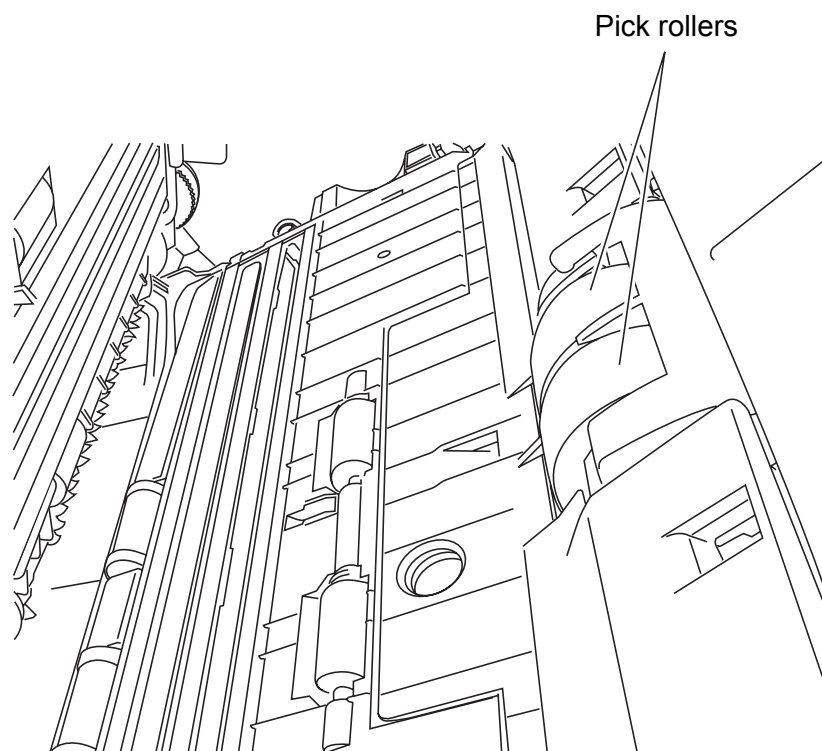

Chapter 4

REPLACING CONSUMABLES

This chapter describes how to replace scanner consumables.

In this chapter, Windows XP screenshots are used as examples.

The screens and operations provided herein may be different from actual ones if the operating system you are using is not Windows XP.

Please take note that, when FUJITSU TWAIN 32 is updated, the screens and operations herein may also be slightly different.

If so, refer to the document provided with the update.



When operating the scanner, the glass inside the ADF becomes very hot. Before you replace the consumables, turn off the power and unplug the AC adapter from the outlet, and wait for at least 15 minutes.

4.1 Consumable and Replacement Cycle	96
4.2 Replacing the Pad ASSY	99
4.3 Replacing the Pick Roller	102

4.1 Consumable and Replacement Cycle

The following table shows the specifications of consumables and guidelines for the replacement cycle.

Description	Parts Number	Standard Replacement Cycle
Pad ASSY	PA03334-0002	After 100,000 scans or one year
Pick roller	PA03334-0001	After 200,000 sheets or one year

The replacement cycles above are rough guidelines for the use of A4/Letter woodfree or wood containing paper 64 g/m² (17 lb). This cycle varies according to the type of the scanned paper and how frequently the scanner is used and cleaned.

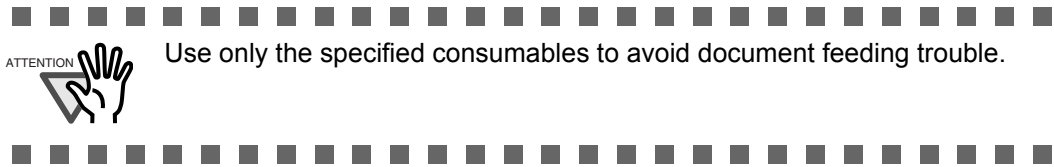

■ Guidelines for Consumable Replacement Cycle

With this product, you can check how many times the consumables have been used for you to replace them with new ones at a right timing.

1. When turning on the power, make sure that the scanner is connected to your personal computer.
Refer to "2.2 Connecting the Scanner to a PC" in fi-5530C2 Getting Started on the CD-ROM for information about connecting the scanner to your personal computer.
2. Double-click on the [Printer and Other Hardware] icon on the Control panel of your personal computer.

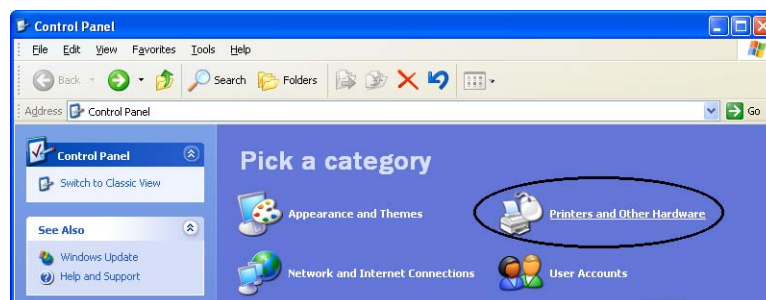

⇒ The [Printer and Other Hardware] window appears.

- In the [Printers and Other Hardware] window, double-click on the [Scanners and Cameras] icon.

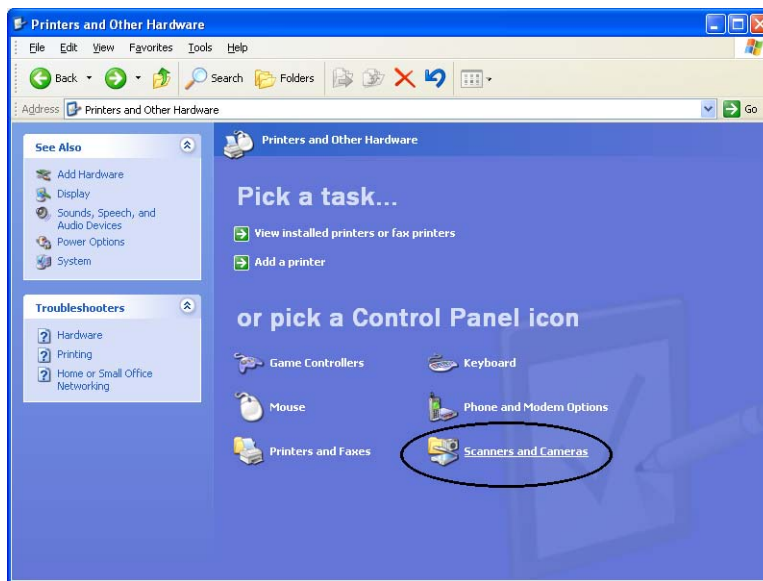

⇒ The [Scanners and Cameras] window is displayed.

- In Windows XP or Windows Server 2003, right-click on the [fi-5530C2dj] icon, and then select [Properties]. In Windows 2000 or Windows Vista, double-click on the [fi-5530C2dj] icon.



⇒ The [fi-5530C2 Properties] dialog box appears.

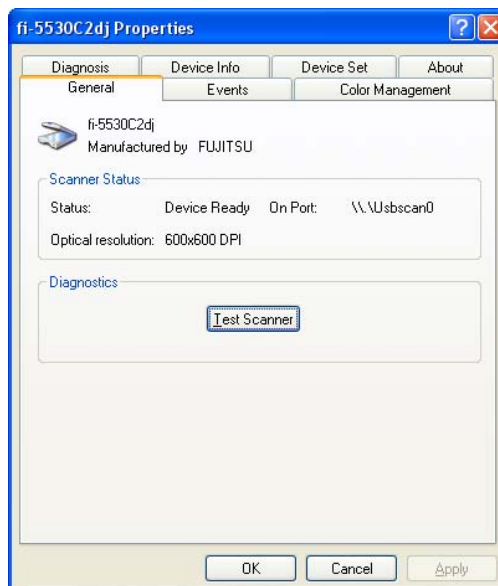

5. Click the [Device Set] tab.

⇒ The following panel appears.

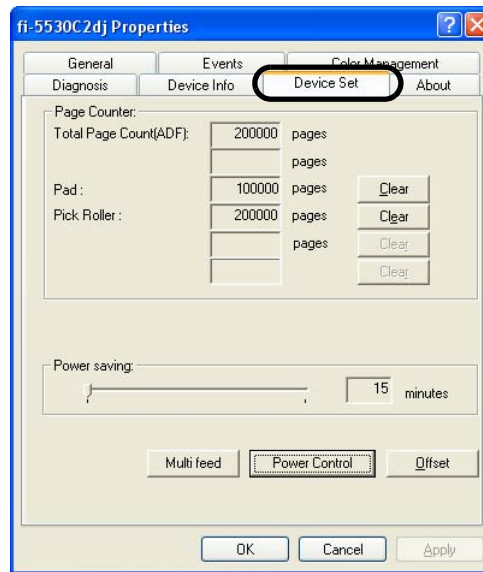

You can check the following information in this panel:

- Total number of scans
- Pad counter (approximate number of scans after resetting the pad counter)
- Pick roller counter (approximate number of scans after resetting the Pick roller counter)
- Remaining ink (When the imprinter is connected, the remaining ink in the imprinter is indicated.)

The following message may appear during use of the scanner:

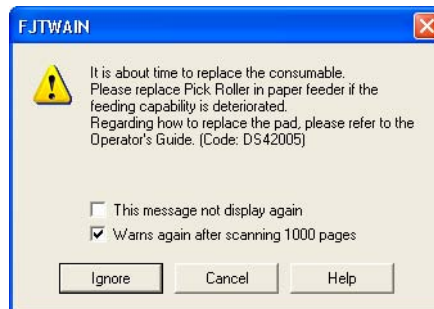

Replace consumables when you see this message.

Click the [Ignore] button to hide this message and continue scanning.

It is recommended that the consumable be replaced at your early convenience.

By default, this message will appear again after another 1,000 scans. If you do not wish to see this message, mark the [This message not display again] checkbox.

To replace the consumable, stop scanning by clicking the [Cancel] button.

4.2 Replacing the Pad ASSY

1. Remove all documents from the ADF paper chute.
2. Open the ADF by pushing down the ADF button.

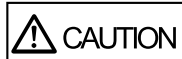
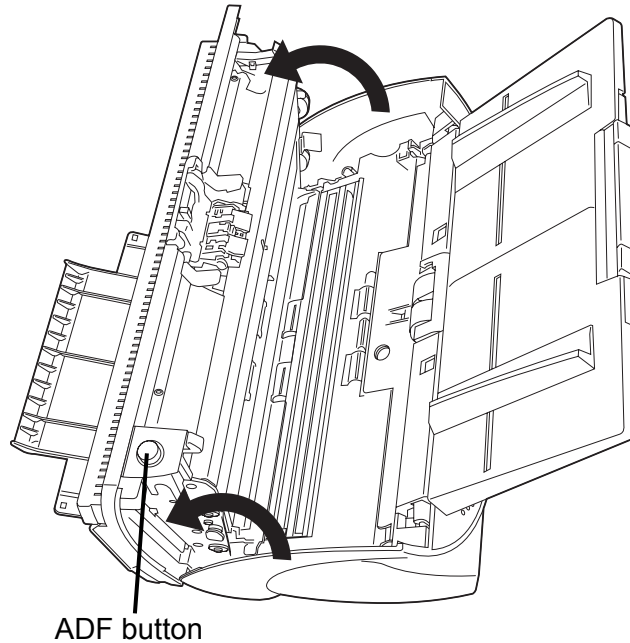

Be careful, the ADF cover may close suddenly and pinch your fingers.

3. Remove the Pad ASSY.
Pinch the Pad ASSY and slide it to the arrow direction, and then remove it.

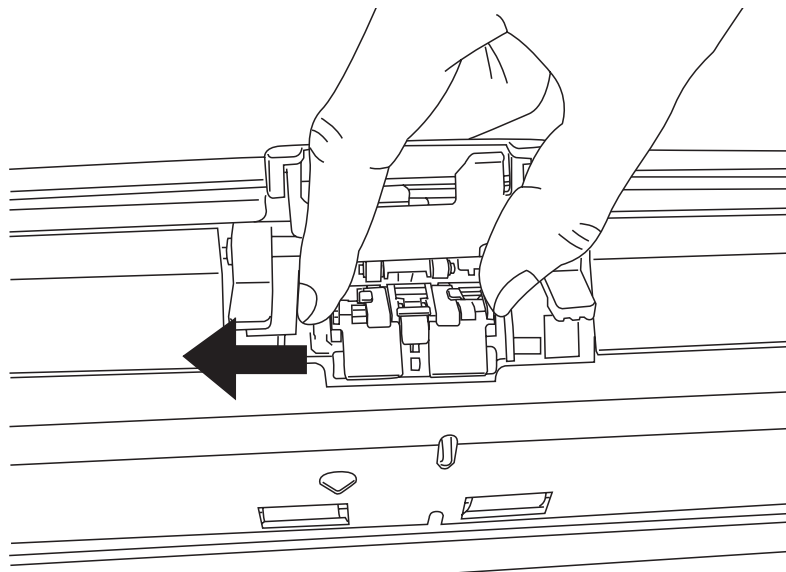

6. Reset the pad counter.

- 1) Check that the scanner is connected to your personal computer and turn on the scanner.
- 2) Open [Scanners and Cameras] from the control panel on your computer.
- 3) Select [Properties] of [fi-5530C2dj].
⇒ The [fi-5530C2dj Properties] dialog box appears.
- 4) Select the [Device Set] tab.
⇒ The following dialog box appears.

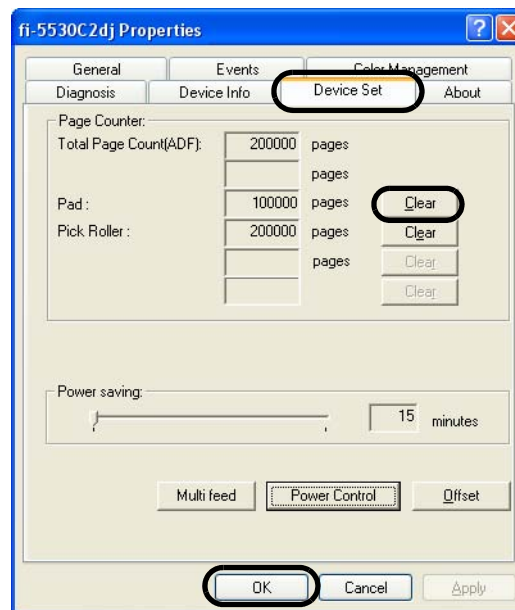

- 5) Click the [Clear] button of [Pad] under [Page Counter], and then the [OK] button.
⇒ The following message appears.

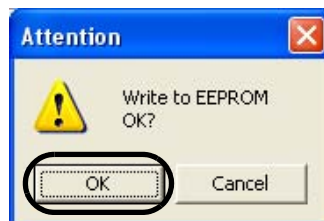

Click the [OK] button.
The Pad counter is reset to "0".

4.3 Replacing the Pick Roller

1. Remove all documents from the ADF paper chute.
2. Remove the ADF paper chute.

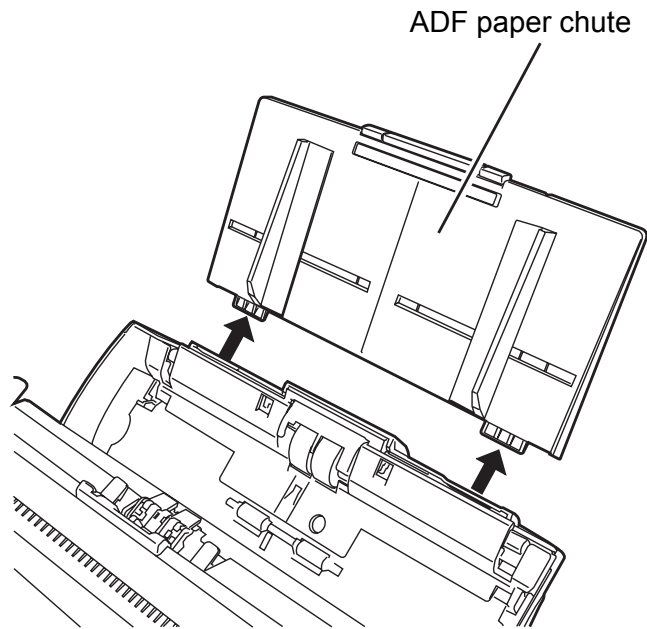

3. Open the ADF by pushing down the ADF button.

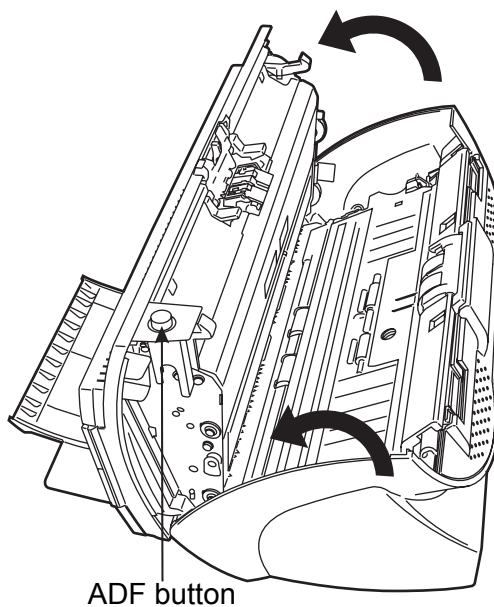

Be careful, the ADF cover may close and pinch your fingers.

4. Remove the Pick roller from the scanner.

- 1) Pinch the knobs on the sheet guide and lift up the sheet guide to remove it.

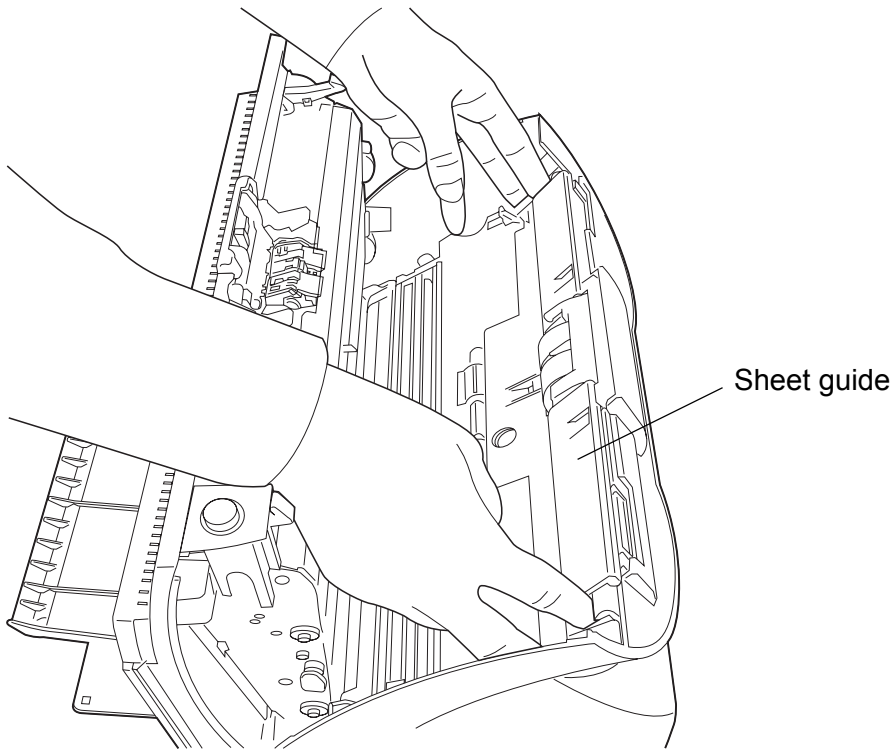

- 2) Rotate the Pick roller bushing in the direction of the arrow.

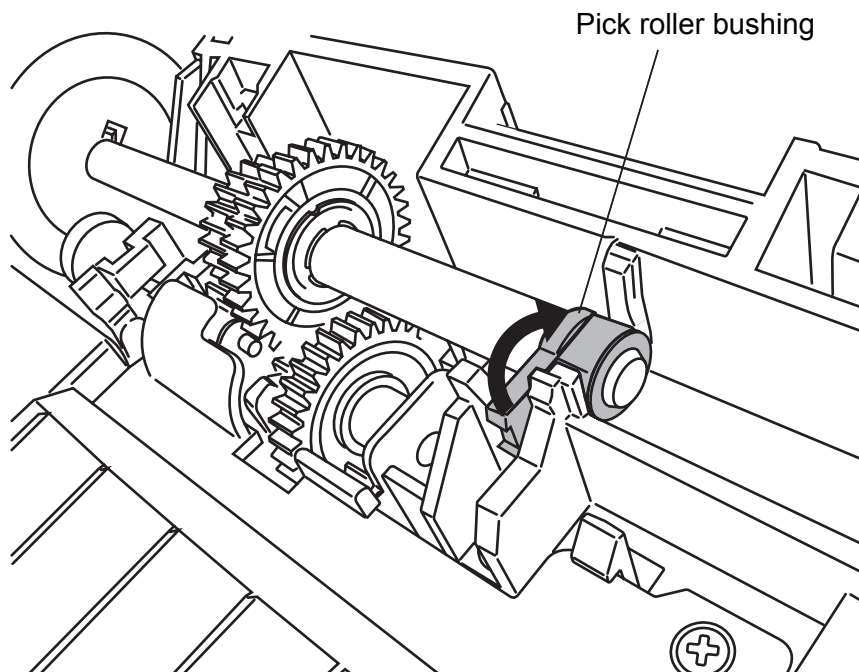

- 3) Remove the Pick roller shaft while lifting it up in the direction of the arrow.

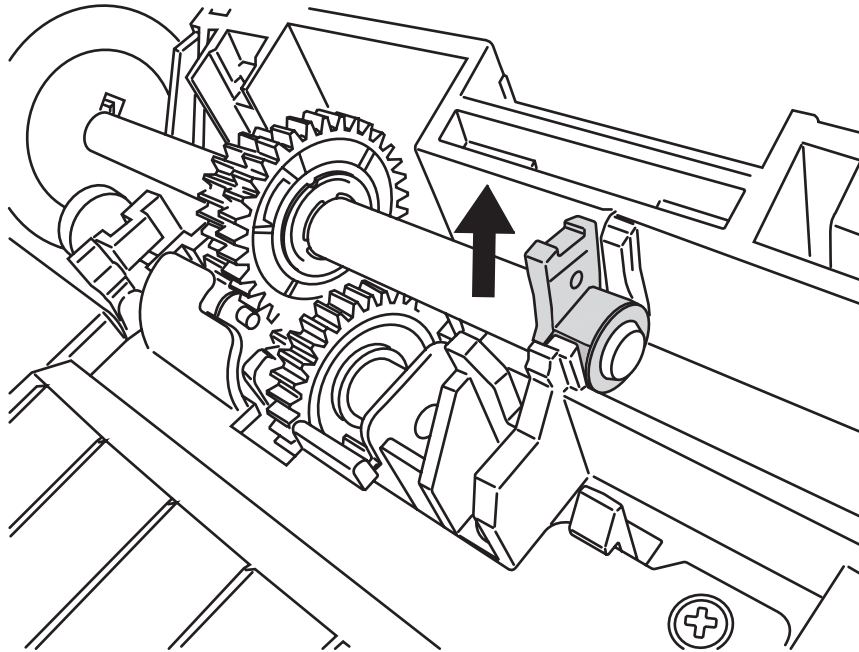

As the Pick roller bushing is firmly fixed, do not try to turn the roller bushing with your fingernails. Use a paper clip for turning the roller bushing if you cannot rotate it with your finger.

5. Remove the Pick roller from the shaft while lifting up the tab on the Pick roller.

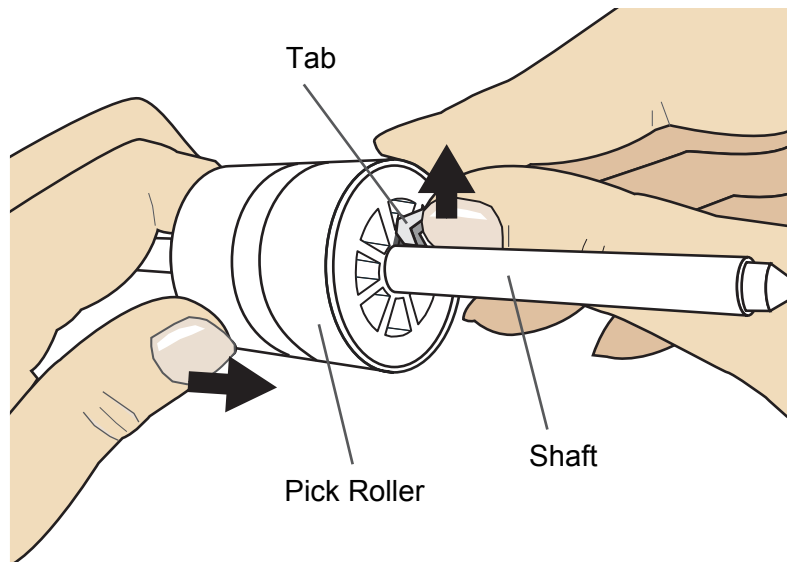



If you lift the pick roller tab with your fingernail, it may hurt your fingernail. Use a paper clip to lift the pick roller tab if you cannot do it with your finger.

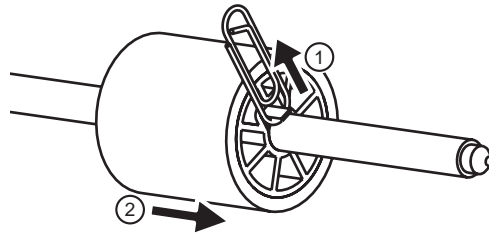

6. Attach new Pick roller.

Insert new Pick roller aligning the screw on the shaft with the slot in the Pick roller.

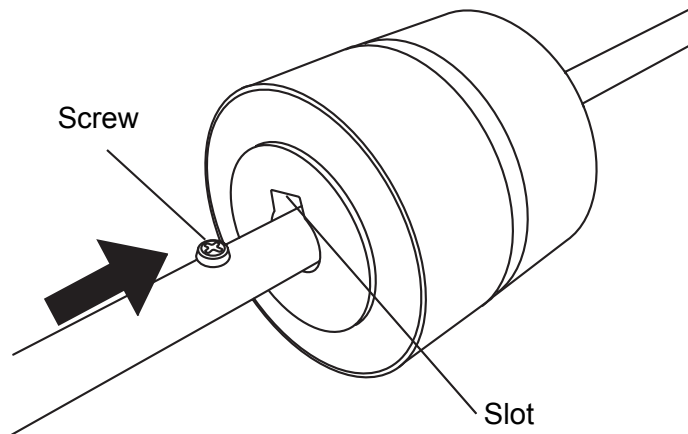

Make sure that the Pick roller is correctly attached. The incompletely-attached Pick roller might cause document jams or other feed errors. When attaching the Pick roller to the shaft, make sure that the roller's tab clicks in to place.

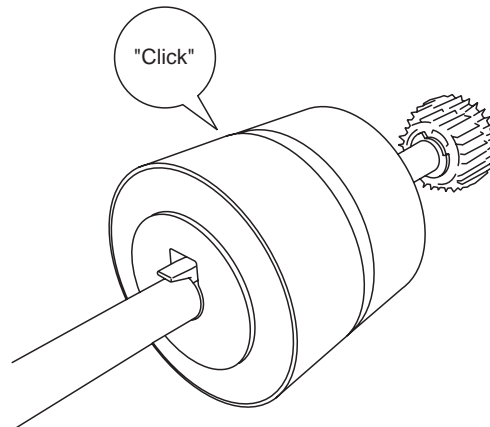

7. Attach the Pick roller shaft to the scanner.

Attach the Pick roller shaft to the scanner in reverse order of removing.

- 1) Set the Pick roller inserting an end of shaft into the shaft hole.

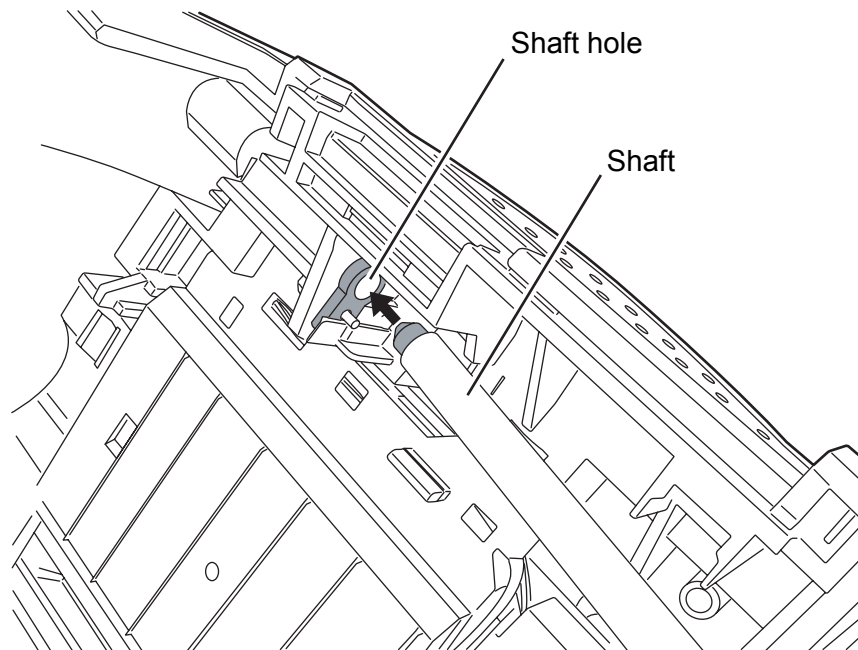

- 2) Turn the Pick roller bushing in the direction of the arrow.

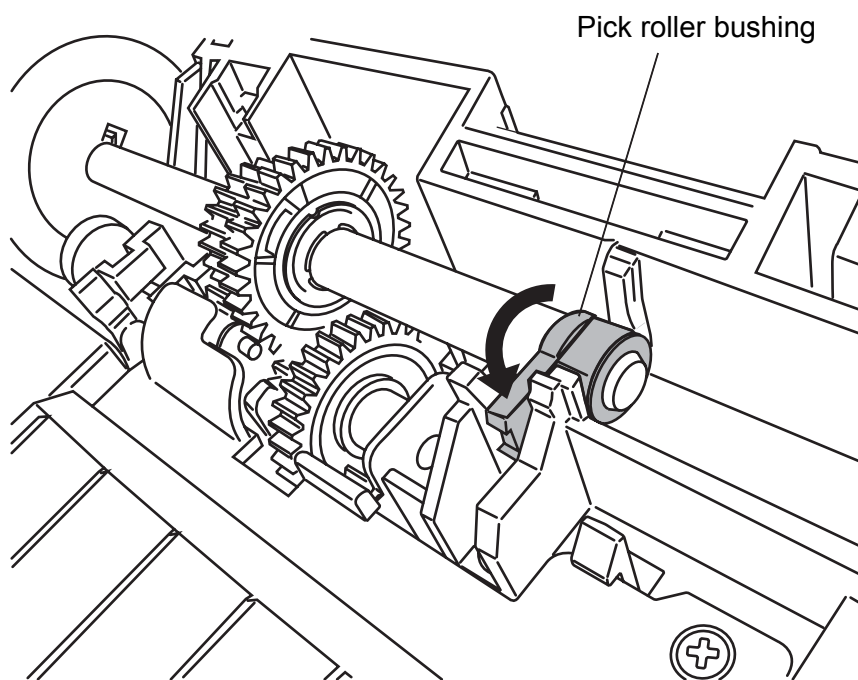

- 3) Attach the sheet guide.

8. Push in the center of the ADF to close it until the ADF button is locked.

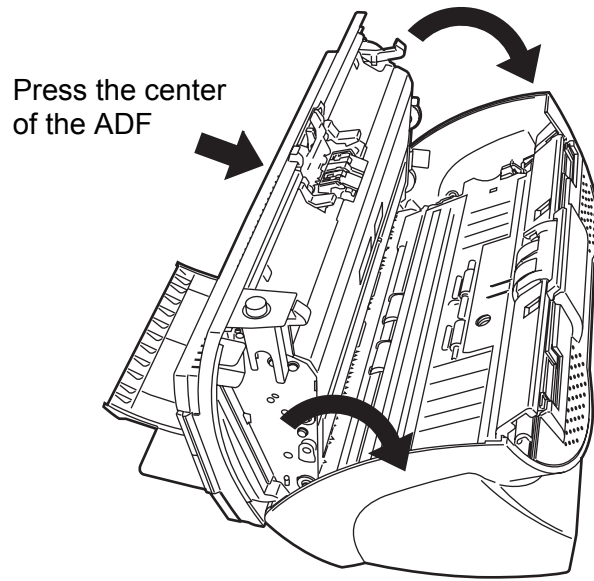

9. Attach the ADF paper chute to the scanner.

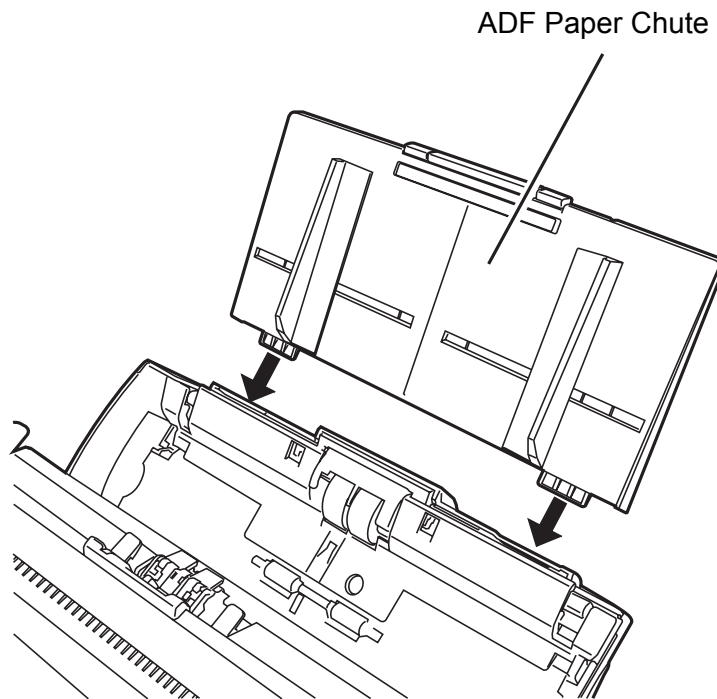

10. Reset the pick counter.

- 1) When turning on the power, check that the scanner is connected to your personal computer.
- 2) Open the [Scanners and Cameras] from the control panel of your personal computer.
- 3) Open the [Properties] of [fi-5530C2dj] from the [Scanners and Cameras].
⇒ The [Properties of fi-5530C2dj] dialog box is displayed.
- 4) Click the [Device Set] tab.
⇒ The following window appears.

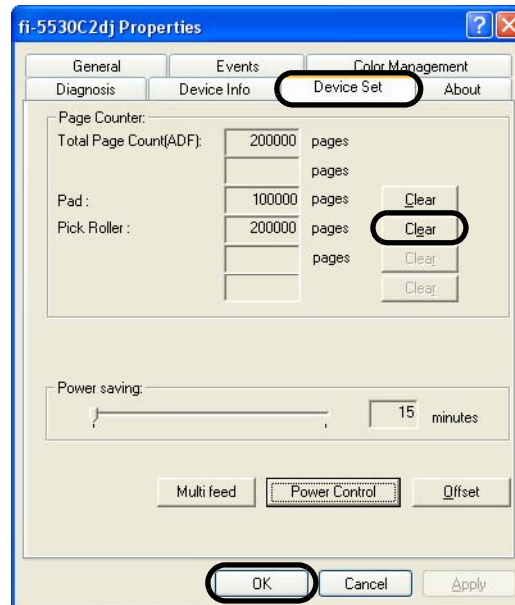

- 5) After clicking the [Clear] button beside [Pick Roller] in [Page Counter], click the [OK] button.
⇒ The following window appears.

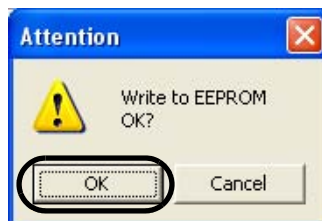

Click the [OK] button.

The Pick roller counter returns to "0".

Chapter 5

TROUBLESHOOTING

This chapter describes what to do when a paper jam occurs, how to troubleshoot, and items to check before contacting an agent at which you bought the scanner, as well as what the labels on the scanner indicate.

5.1 Removing Jammed Documents	110
5.2 Error Indications in the Function Number Display	112
5.3 Remediating Common Troubles	114
5.4 Items to check before contacting the agent where you bought the scanner	127
5.5 Checking Labels on the Scanner	130

5.1 Removing Jammed Documents

If a document jam occurred, follow the procedure below to remove the jammed documents.



- Take care not to get injured when removing the jammed documents.
- Be careful not to get neckties, necklaces, etc. entangled in the scanner when removing the jammed documents.
- The surface of the glass may become hot during operation. Take care not to get burned.

1. Remove all documents from the ADF paper chute.
2. Open the ADF by pushing down the ADF button.

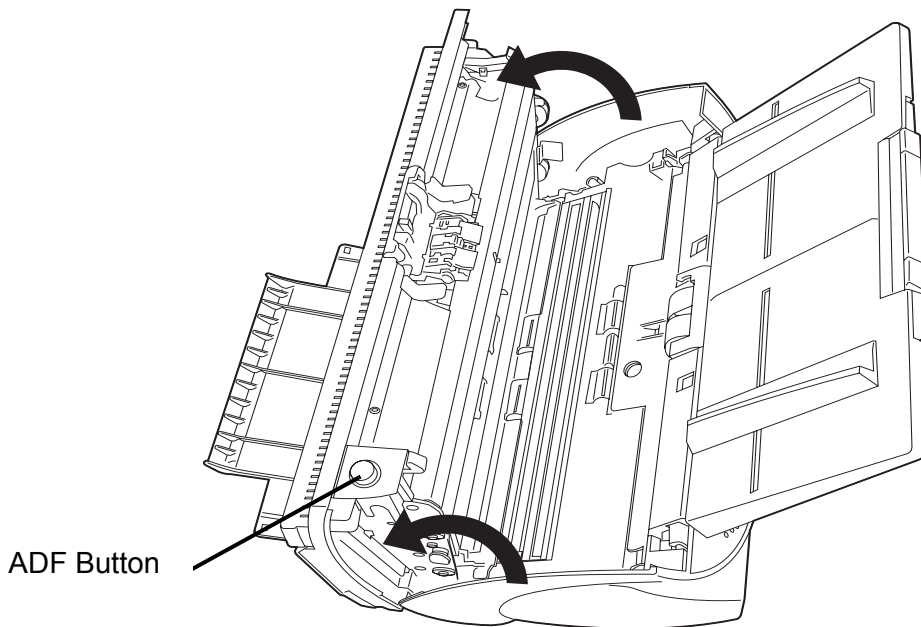

The ADF cover may close accidentally. Be careful not to pinch your fingers.

3. Remove the jammed documents.



Staples, paper clips, etc. cause document jams. Be sure to fully check the document and feed path, and remove any small metal objects such as these.

Also, before you start scanning, be sure to remove any staples, clips, etc. from the document.



4. Push in the center of the ADF to close it until the ADF button is locked.

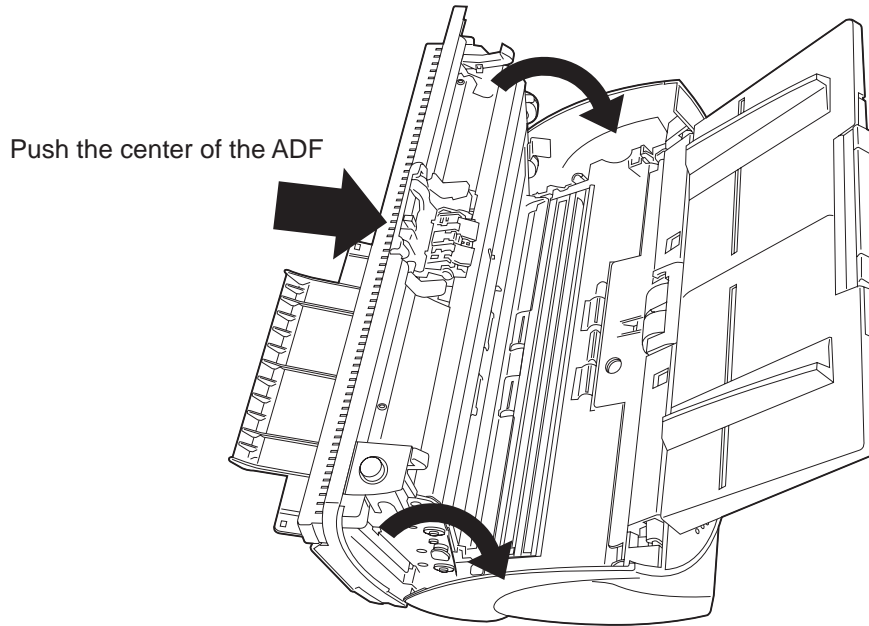

- Make sure that the ADF is completely closed. When it is not completely closed, document jams or feeding errors may occur.
- When the scanning is completed at the pre-determined sheet or canceled, the document might remain inside the ADF even though any error message is not displayed.

Follow the procedure below to remove the documents remaining in the ADF.

1. Remove all documents from the ADF paper chute.
2. Open the ADF by pushing down the ADF button.
3. Remove the remaining documents.
4. Push in the center of the ADF to close it until the ADF button is locked.



5.2 Error Indications in the Function Number Display

When any error occurs, the operator panel indicates "U" followed by a number alternately for temporary errors, or "E" followed by a number for device alarms (permanent error).

Temporary errors can be resolved by the operator, but the device alarm requires recovery works by support engineers.

When the Error Recovery Guide is installed on your personal computer and if any error or device alarm has occurred, this software displays information such as error names and error codes regarding the error/alarm. Take notes of the information and click [Details] on its window to learn detailed information for troubleshooting.

■ Temporary Errors:

A number appearing in alternation following the "U" refers to the following type of errors:

Indication	Meaning	Solution
U1	A paper feed error occurred.	Remove the jammed documents. (Refer to "5.1 Removing Jammed Documents" on page 110.) Confirm that the document meet the paper conditions for scanning. (Refer to "6.2 Document Quality" on page 133.)
U2	A multifeed error occurred.	Press the [Send to] button on the Operator Panel. The papers that were multi fed will be ejected.
U6	The print cartridge is not set.	This is a temporary error related with the Imprinter option (sold separately). For details refer to fi-553PR Operator's Guide, chapter "5 Error Message".



The Error Recover Guide is stored in Setup CD-ROM. For installing the application software, refer to "2.3 Installing the Scanner Application" in fi-5530C2 Getting Started.

■ Device alarms:

A number appearing in alternation following the "E" refers to the following type of device alarms:

Indication	Meaning	Solution
E2	Trouble in the optical system (front).	When you encounter any alarm, turn off and on the scanner. If the alarm is still displayed on the Function Number Display, contact the dealer where you purchased the scanner or an authorized FUJITSU scanner service provider.
E3	Trouble in the optical system (back).	
E4	The motor fuse has blown out.	
E6	Trouble in the operator panel.	
E7	Trouble occurred in the internal memory (EEPROM).	
E8	The SCSI interface fuse has blown out.	
E9	An error in the image memory.	
Ec	An alarm in the memory.	
Ed	Trouble in the SCSI interface controller	
EF	Trouble in the Background switching mechanism	

5.3 Remediating Common Troubles

This section describes troubles that may occur during scanning and how to remedy them.

Before you ask for repair service, check the following flowcharts.

If you cannot solve the problem after checking the remedies in the flowcharts, check the items in ["5.4 Items to check before contacting the agent where you bought the scanner"](#) (page 127) and then contact the agent at which you bought the scanner or an authorized FUJITSU scanner service provider.

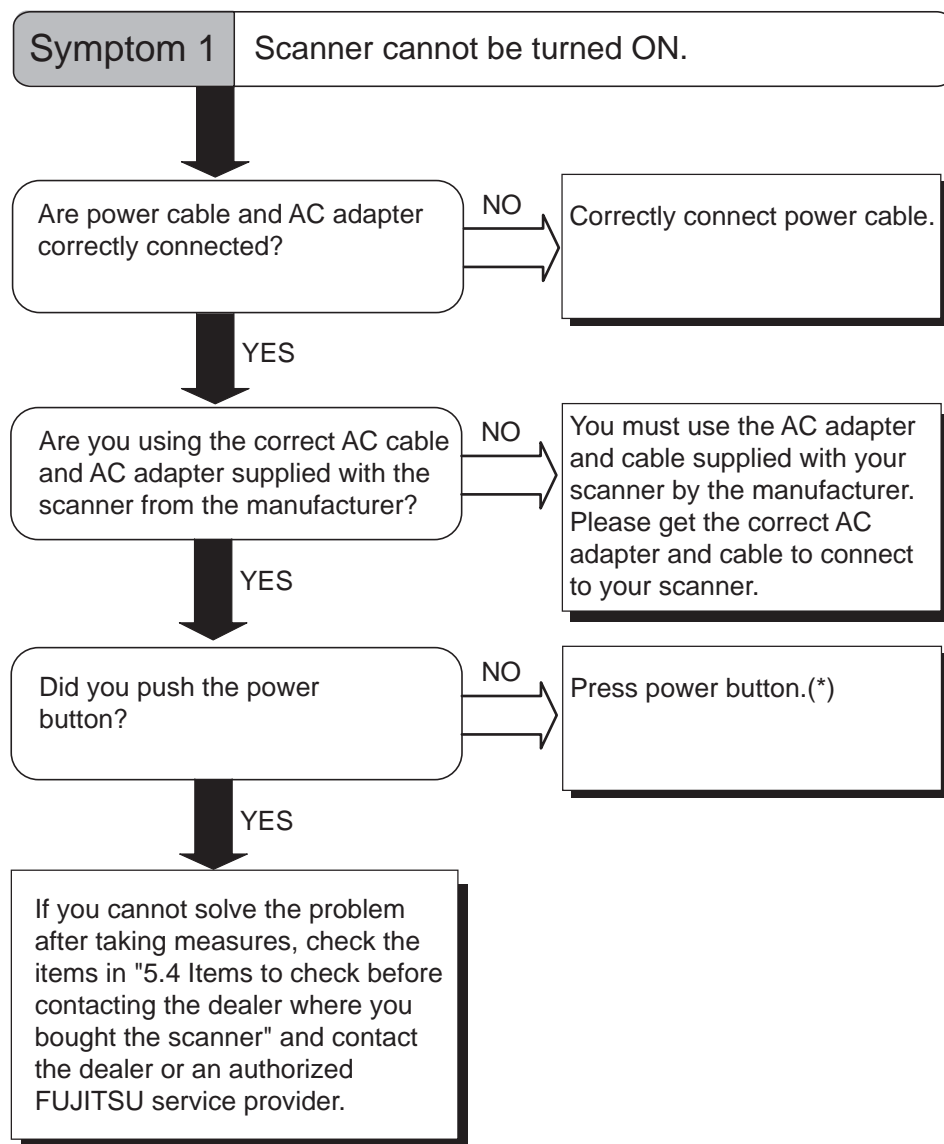

*) For details about how to turn the scanner on, refer to ["1.1 Turning the Scanner ON"](#) on [page 2](#).

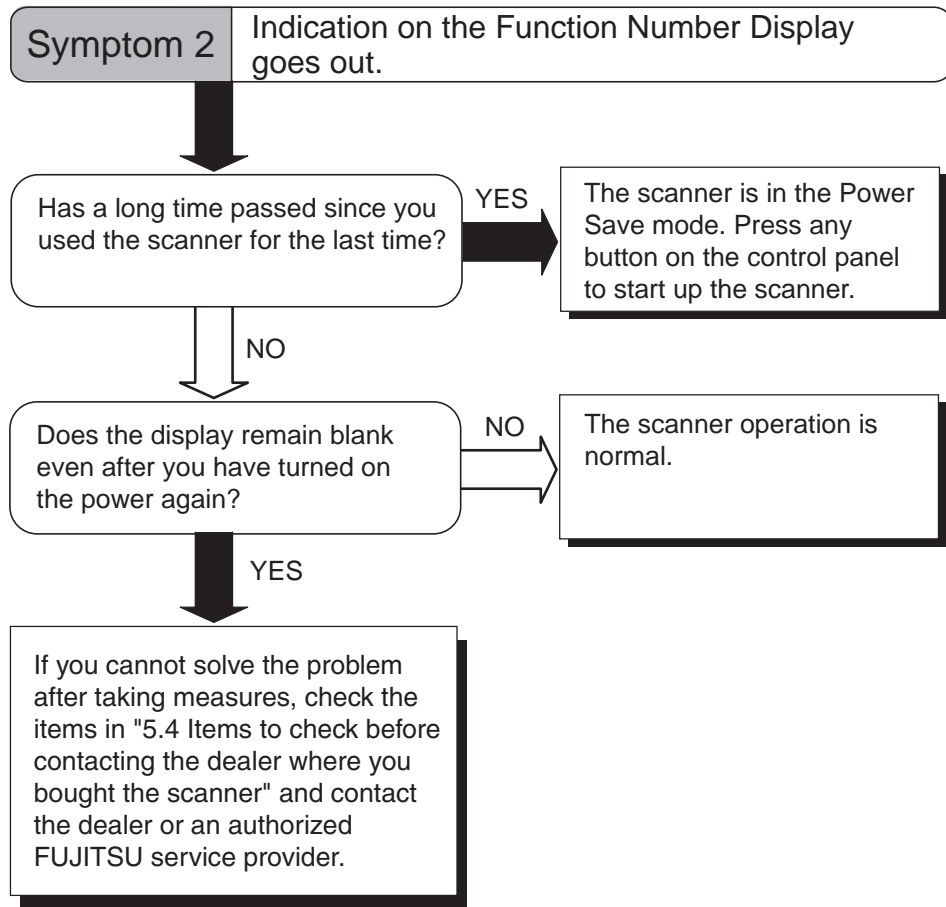

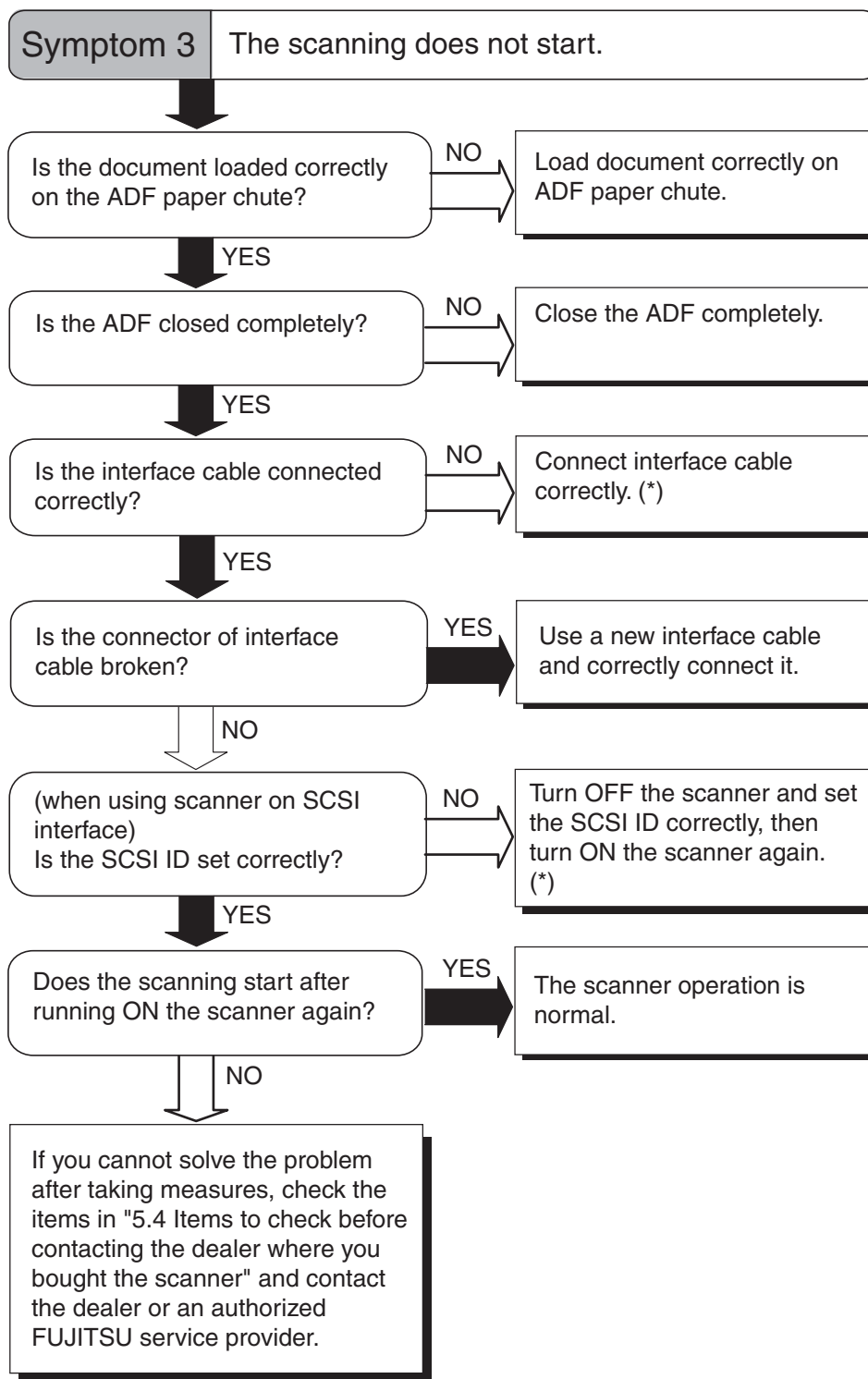

*) For details, refer to Getting Started "2.2 Connecting the scanner to your PC".

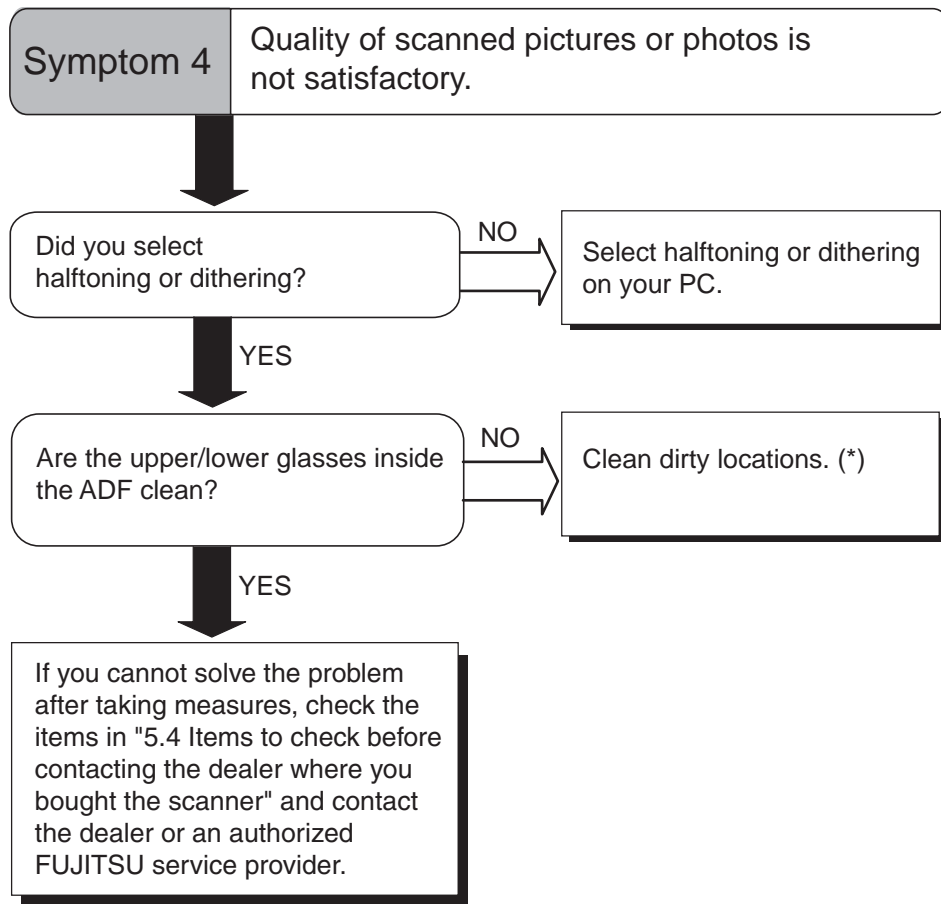

*) For details on how to clean dirty locations, refer to ["3 DAILY CARE" on page 87.](#)

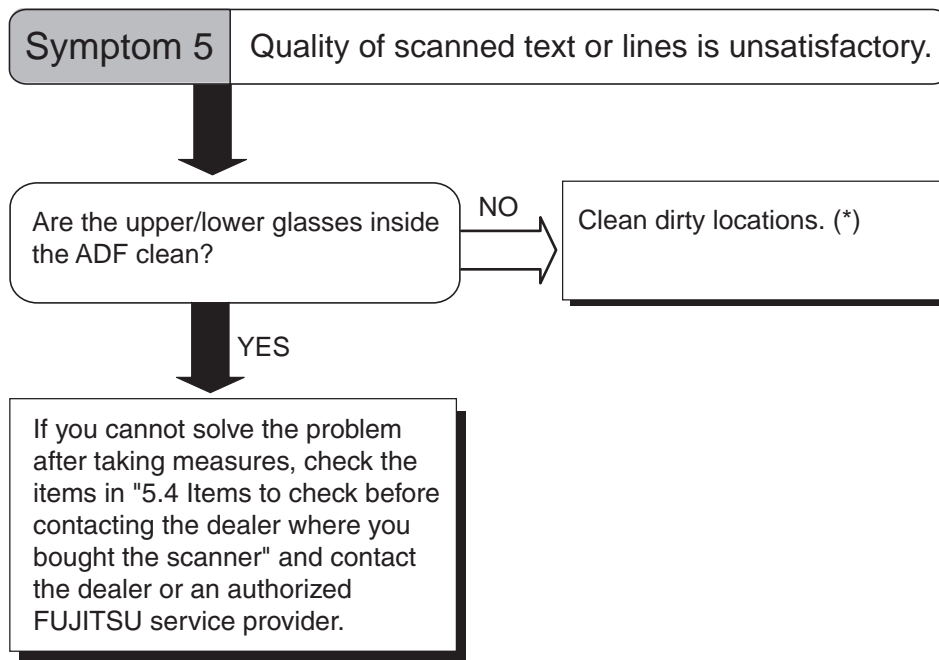

*) For details on how to clean dirty locations, refer to ["3 DAILY CARE" on page 87.](#)

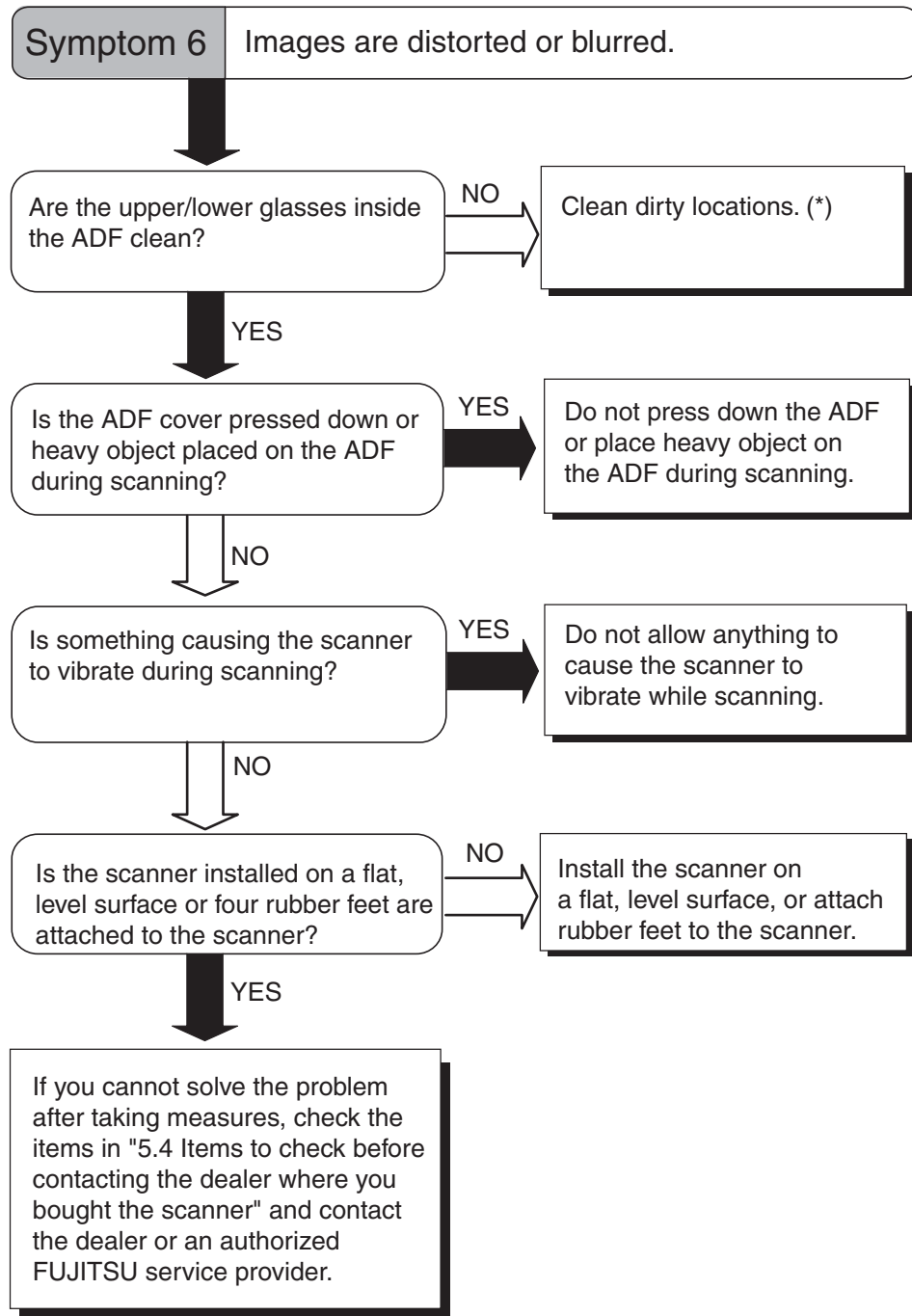

*) For details on how to clean dirty locations, refer to ["3 DAILY CARE" on page 87.](#)

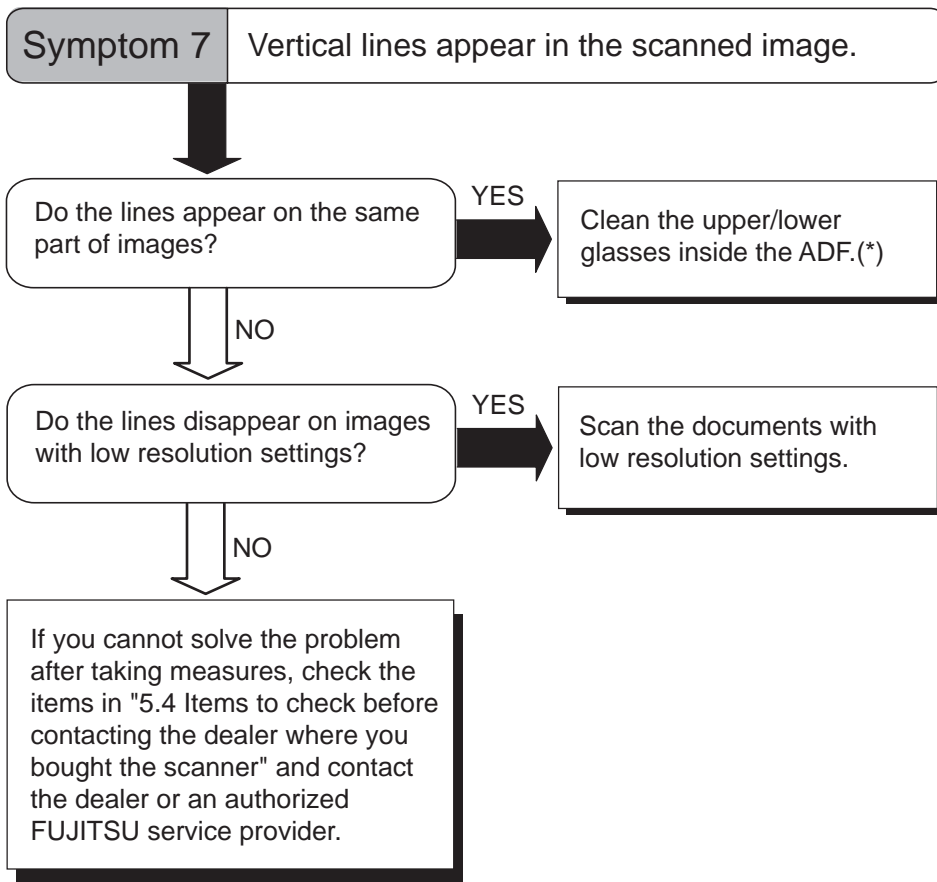

*) The ADF glass, refer to ["3.2 Cleaning the ADF"](#) on page 90.

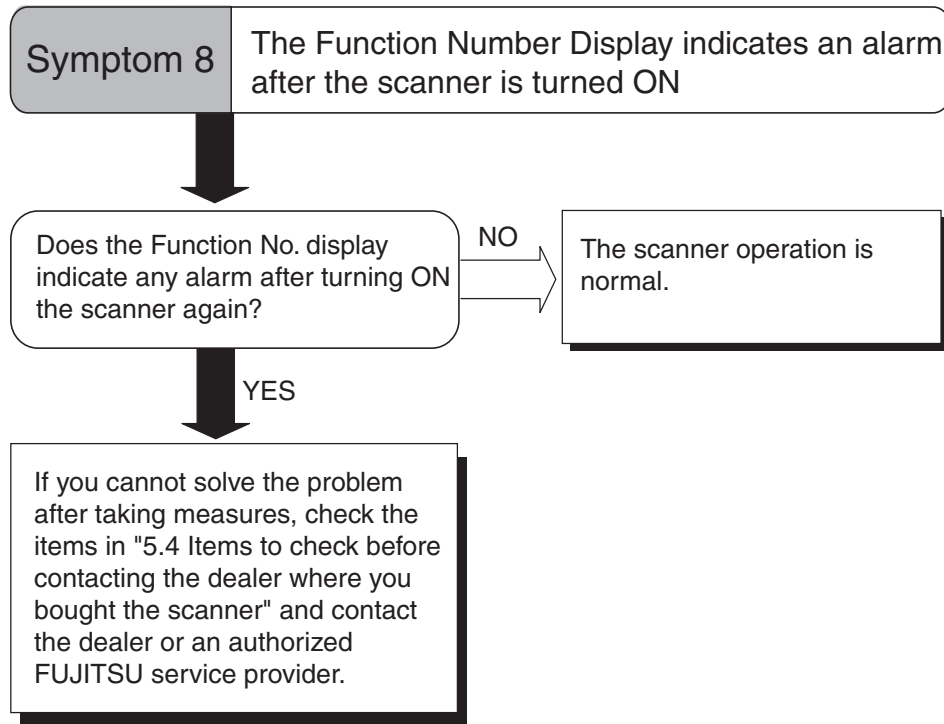

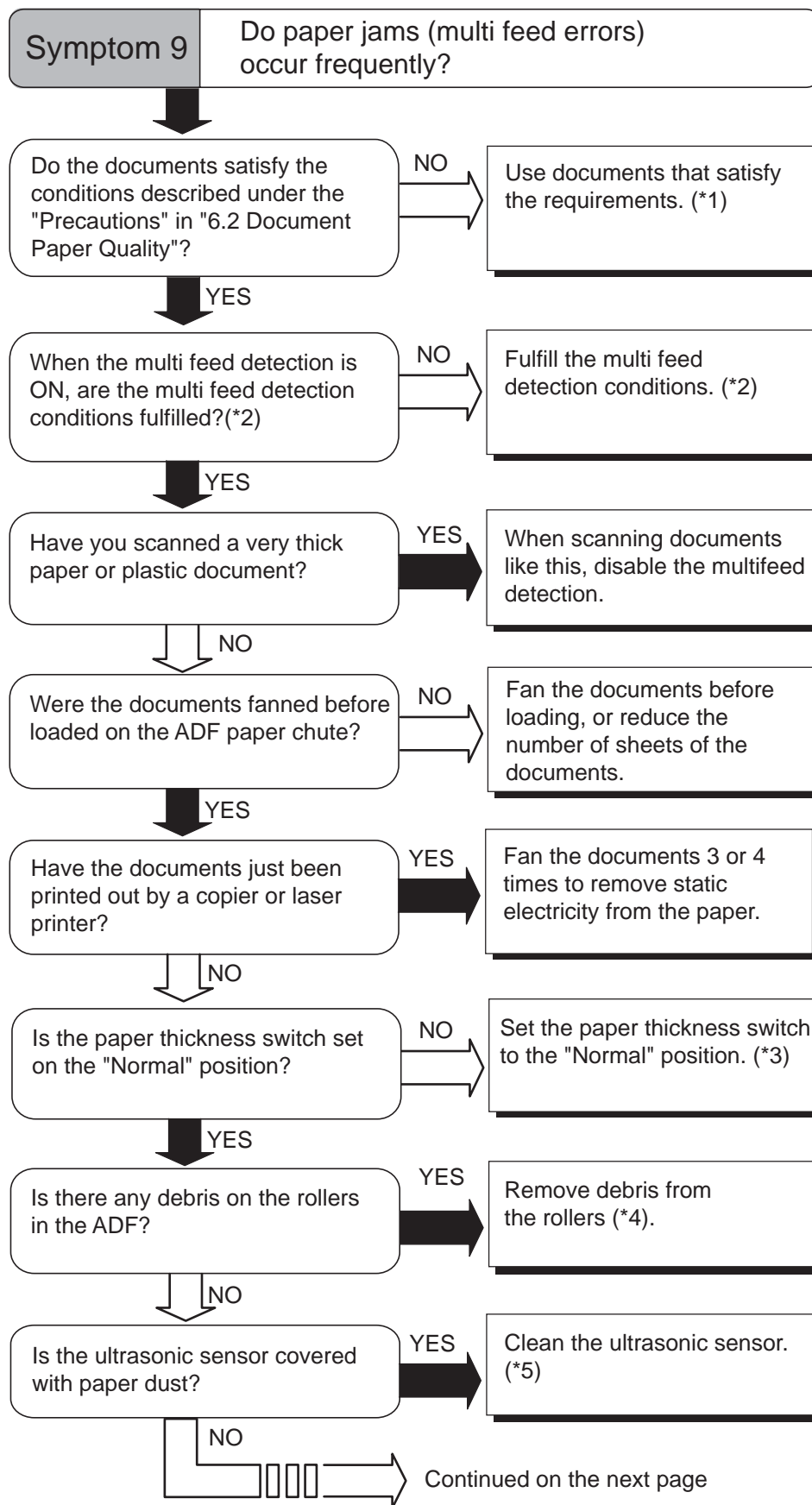

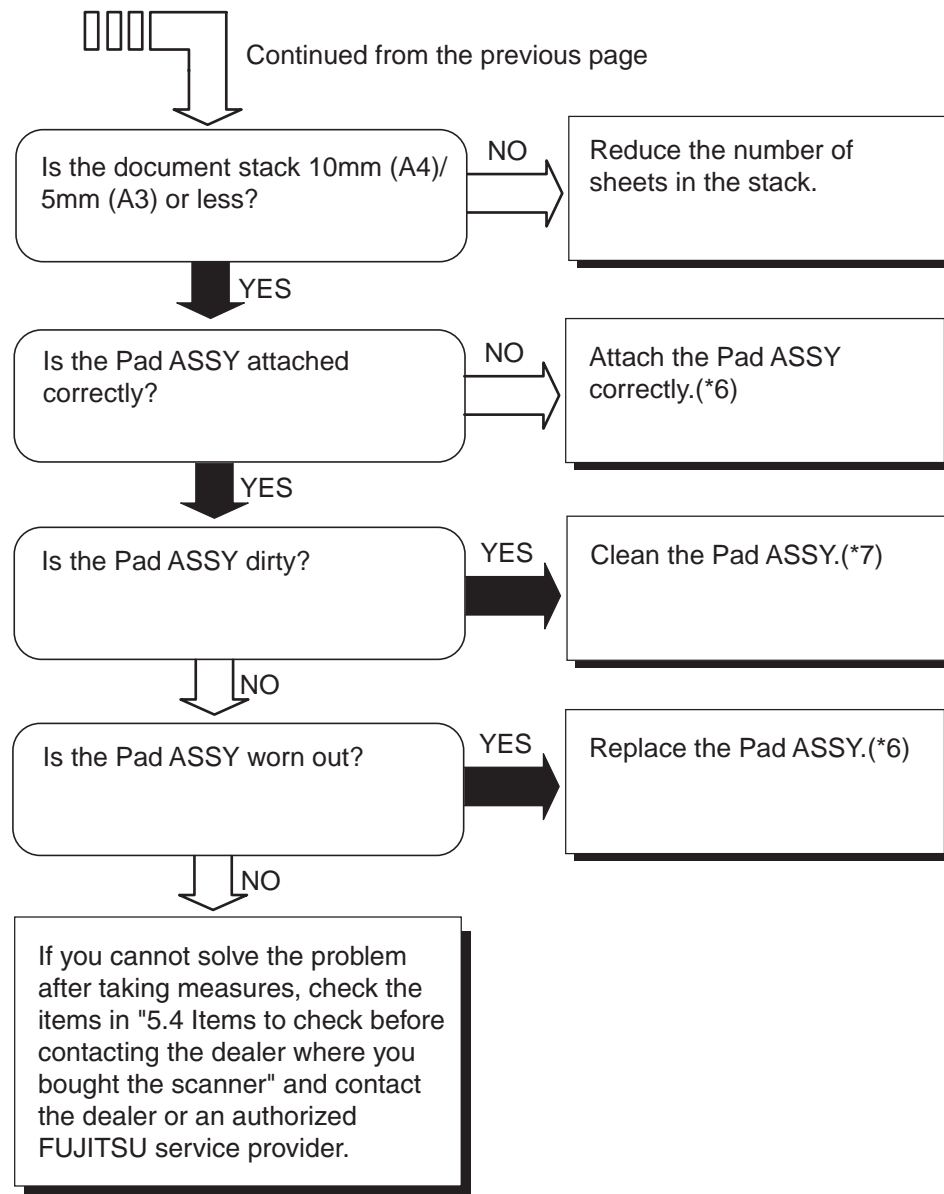

*1) For details on the requirements, refer to ["6.2 Document Quality"](#) on page 133.

*2) For details on multifeeds, refer to ["6.5 Specifying How to Detect Multifeed"](#) on page 139.

*3) For details on how to set paper thickness switch, refer to ["2.3 Scanning Thin Documents"](#) on page 48.

*4) For details on how to clean the rollers, refer to ["3.2 Cleaning the ADF"](#) on page 90.

*5) For details on how to clean the Ultrasonic sensor, refer to the ["3.2 Cleaning the ADF"](#) on page 90.

*6) For details on how to replace (or attach) the Pad ASSY, refer to ["4.2 Replacing the Pad ASSY"](#) on page 99.

*7) For details on how to clean the Pad ASSY, refer to ["3.2 Cleaning the ADF"](#) on page 90.

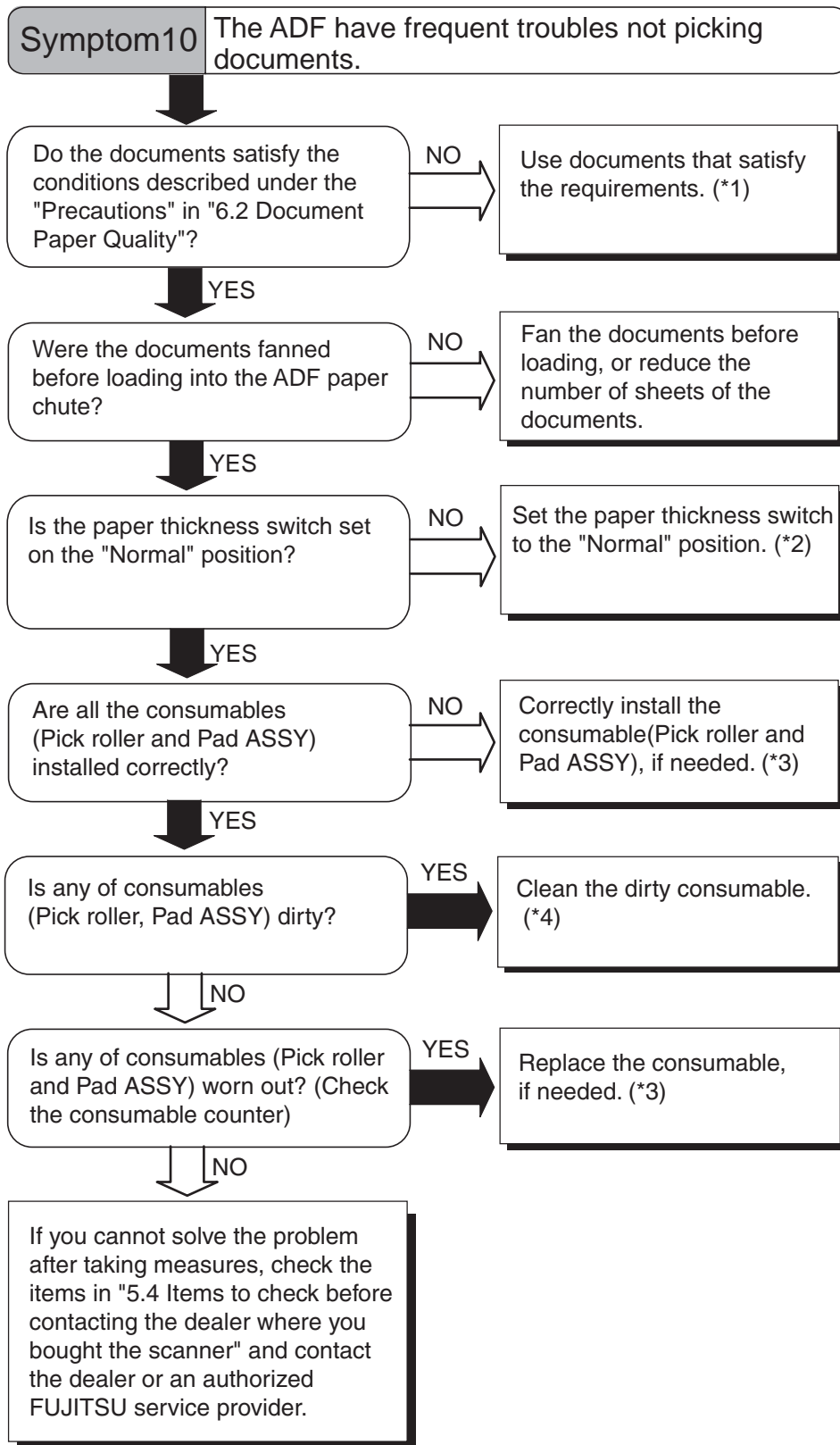

*1) For details, refer to ["6.2 Document Quality"](#) on page 133.

*2) For details, refer to ["2.3 Scanning Thin Documents"](#) on page 48.

*3) For details, refer to ["4 REPLACING CONSUMABLES"](#) on page 95.

*4) For details, refer to ["3.2 Cleaning the ADF"](#) on page 90.

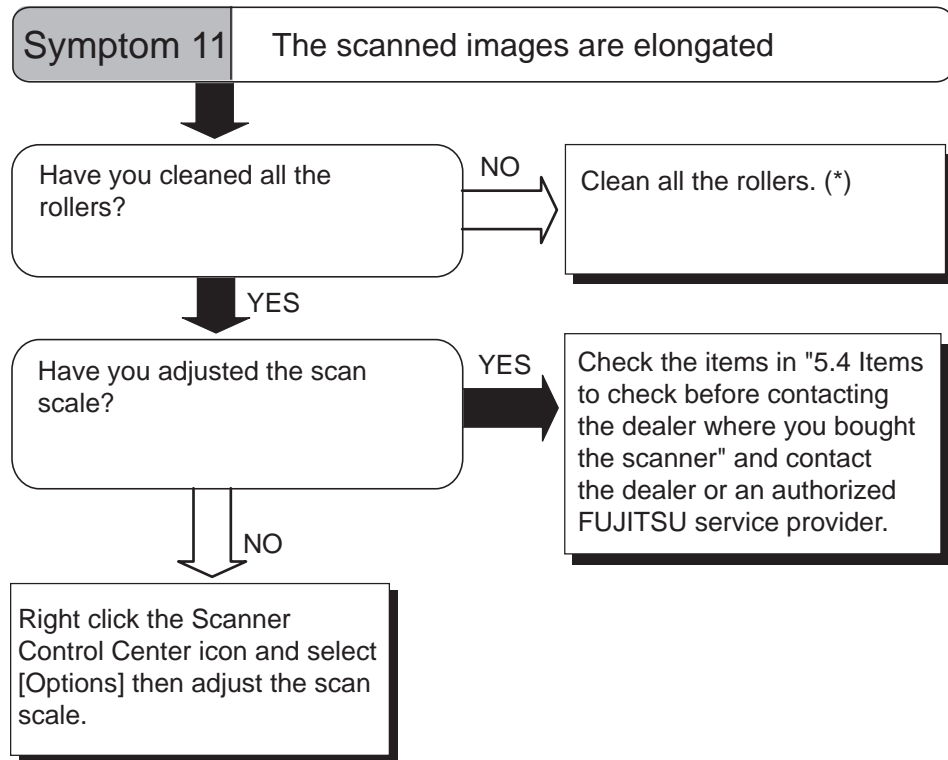

*) For details on how to clean the rollers, refer to ["3.2 Cleaning the ADF" on page 90](#).

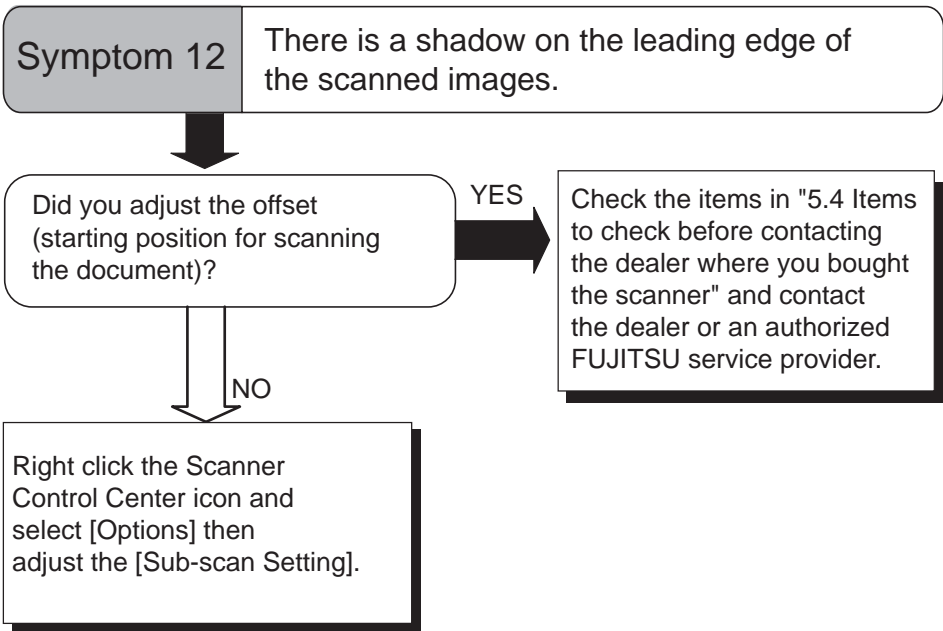

5.4 Items to check before contacting the agent where you bought the scanner

Check the following items before you contact the agent where you bought the scanner.

■ General Details

Item	Findings
Model	fi-5530C2
Serial Number	(Example) 000001 For details on the serial number, refer to "5.5 Checking Labels on the Scanner" on page 130.
Production date	(Example) 2007-07 (July, 2007) For details on the production date, refer to "5.5 Checking Labels on the Scanner" on page 130.
Date of purchase	
Symptom	
Frequency of trouble	

■ Problems in Installation or PC connection

- Problems occur when connecting to your computer

Item	Findings
OS	
Displayed error message	
Interface	(Example) SCSI interface
Interface controllers	(Example) made by Adaptec SCSI Card 2940AU

- Problems in the feeding system

Item	Findings
Document type	
Main purpose of use	
Last cleaning date	
Last consumables replacement date	
Operator panel status at trouble	

- Problems in the imaging system

Item	Findings
Type and version of scanner driver	
Type of interface controller	(Example) made by Adaptec SCSI Card 2940AU
OS (Windows®)	
Application software	(Example) ScandAll PRO, Acrobat

5.4 Items to check before contacting the agent where you bought the scanner

- Others

Item	Findings
Can both the original document and the scanned document image (output paper with Fax) be sent out by e-mail or Fax?	

5.5 Checking Labels on the Scanner

■ Positions of Labels on the Scanner

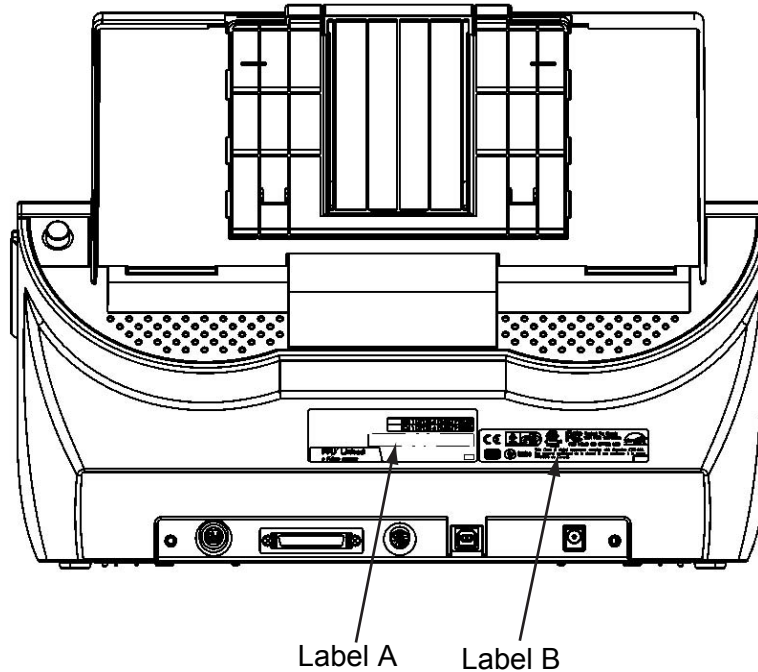

Label A (example): Indicates scanner information.

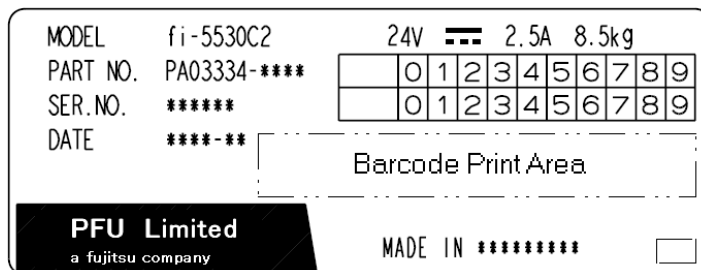

Label B (example): Indicates various standards that the scanner conforms with.

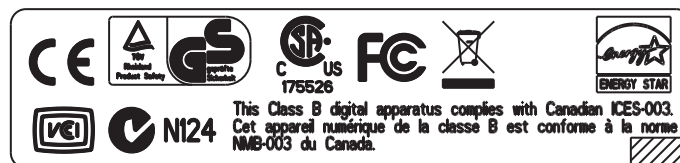

Chapter 6

DOCUMENT SPECIFICATIONS FOR ADF

This chapter describes the required document sizes and paper quality for ensuring a correct operation when scanning documents on the ADF.

6

6.1 Document Size	132
6.2 Document Quality	133
6.3 Maximum ADF Capacity	137
6.4 Area Not To Be Perforated	138
6.5 Specifying How to Detect Multifeed	139

6.1 Document Size

The following shows the size of documents that can be scanned.

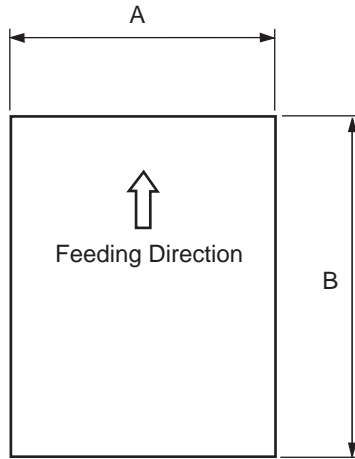

Maximum		Minimum	
A	B	A	B
297 (11.7 in)	863.6 (34 in)	53 (2.0 in)	74 (2.9 in)

(Unit: mm)

6.2 Document Quality

This section describes the types and thicknesses of documents that can be scanned stably, and precautions to follow.

■ Document Type

The recommended following paper types are:

- Woodfree paper
- Wood containing paper

When using documents of a paper type other than the above, perform a test-scanning with a few sheets of the same type before executing the actual task in order to check whether or not the documents can be scanned.

■ Document Thickness

Paper thickness is expressed by "paper weight." The following shows the paper weights that can be used on this scanner:

- 52 g/m² to 127 g/m² (13.9 lb to 34.0 lb)

Only a paper weight of 127 g/m² (34.0 lb) is allowed for A8-size documents.

■ Precautions

The following documents may not be scanned successfully.

- Documents of non-uniform thickness (e.g. envelopes and documents with photographs attached)
- Wrinkled or curled documents (Refer to HINT on page 135.)
- Folded or torn documents
- Documents with pictures and/or sticky notes attached
- Tracing paper
- Coated paper
- Carbon paper
- Carbonless paper
- Photosensitive paper
- Perforated or punched documents
- Documents that are not square or rectangular
- Very thin documents
- Photographs

Do not use the following documents:

- Paper-clipped or stapled documents
- Documents on which the ink is still wet
- Documents smaller than A8 (Portrait) in size
- Documents wider than A3 or 11x 17 in size
- Documents of materials other than paper such as the fabric, metal foil, transparency



- When scanning semi-transparent documents, slide the [Brightness] bar to light to avoid bleed through.
- To prevent the rollers from becoming dirty, avoid scanning documents containing large areas written or filled in pencil. If scanning of such documents is inevitable, clean the rollers more frequently.



- Carbonless paper contains chemical substances that may harm the Pad ASSY or rollers (e.g. Pick roller) when documents are fed. Pay attention to the following:

Cleaning: If document jams occur frequently, clean the Pad ASSY and the Pick roller. For details on cleaning the Pad ASSY and the Pick roller, refer to "[3.2 Cleaning the ADF](#)" on page 90.

Replacing parts: The service life of the Pad ASSY and the Pick roller may be shortened compared to the case of scanning wood containing paper documents.

- If paper containing wood is scanned, the service life of the Pad and Pick roller may become shorter than that of the Pad and Pick roller used for scanning only woodfree paper.
- The pad or rollers of the scanner could be damaged if photographs or sheets of paper attached to the scanned document have contact with the pad or rollers during scanning.
- Scanning documents of calendered paper such as photographs may damage the surface of them.



When using the ADF, the leading edge of all document sheets must be evenly aligned. Make sure that curling at the leading edge is within the following tolerances:

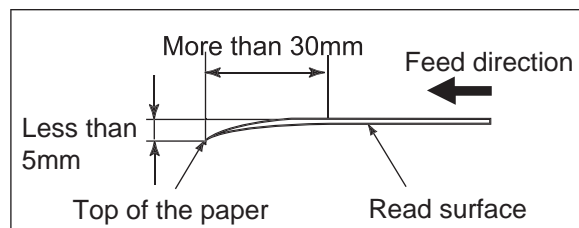
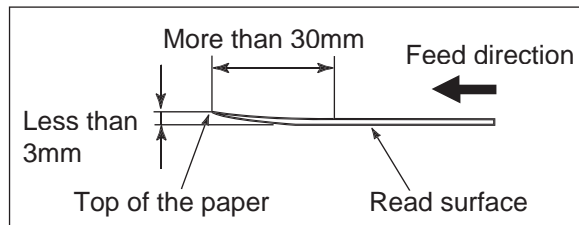



This scanner can scan ID cards through the Automatic Document Feeder with the following precautions.

- Place one card at a time into the Auto Document Feeder.
- ID card feeding requires the card to be fed through the Auto Document Feeder in portrait mode as in the following figure.

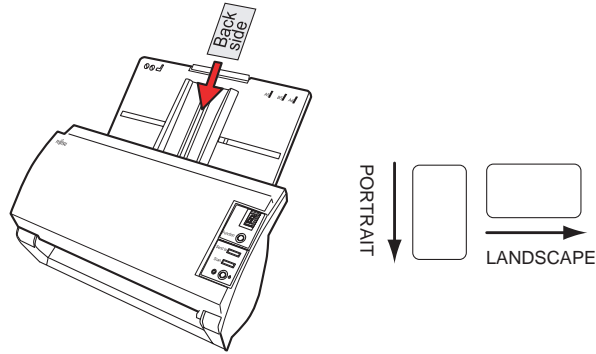

- Smooth cards should be placed face down in the Auto Document Feeder.

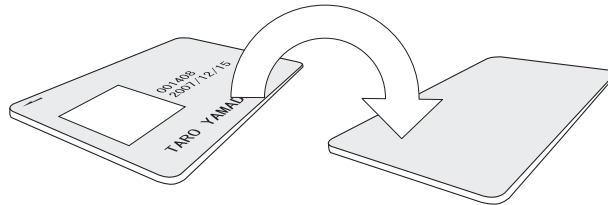

- The card to be scanned should be within the ISO7810 compliance, type ID-1.
ISO7810-compliant, Type ID-1 card
Material: PVC (Poly vinyl chloride) or PVCA (Polyvinyl chloride acetate)
Dimensions: 3.4 inch (height) x 2.1 inch (width) / 86 mm x 54 mm
Thickness: 0.03 ± 0.003inch / 0.76 ± 0.08mm
- Embossed cards (on which a raised effect is created) cannot be scanned.
- Cards that are excessively rigid or less flexible may not feed smoothly and excessive noise may occur.
- Cards should be clean from oil and without labels.
- Cards cannot be scanned when the imprinter is installed.

6.3 Maximum ADF Capacity

The maximum number of sheets that can be loaded on the ADF paper chute is determined by the size and weight of the documents. The following graph shows the maximum document loading capacity of ADF with respect to paper weight.

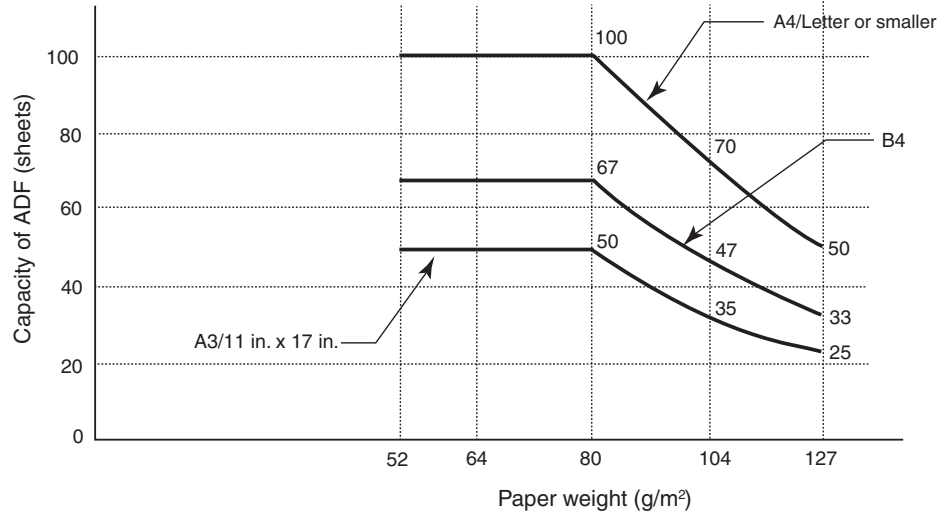

Paper weight conversion table

Unit	Conversion						
g/m ²	52	64	75	80	90	104	127
lb	13.9	17.0	20.0	21.0	24.0	27.9	34.0



6.4 Area Not To Be Perforated

When using the ADF, document trouble might occur if there is any punched hole in the shaded area in the following figure.

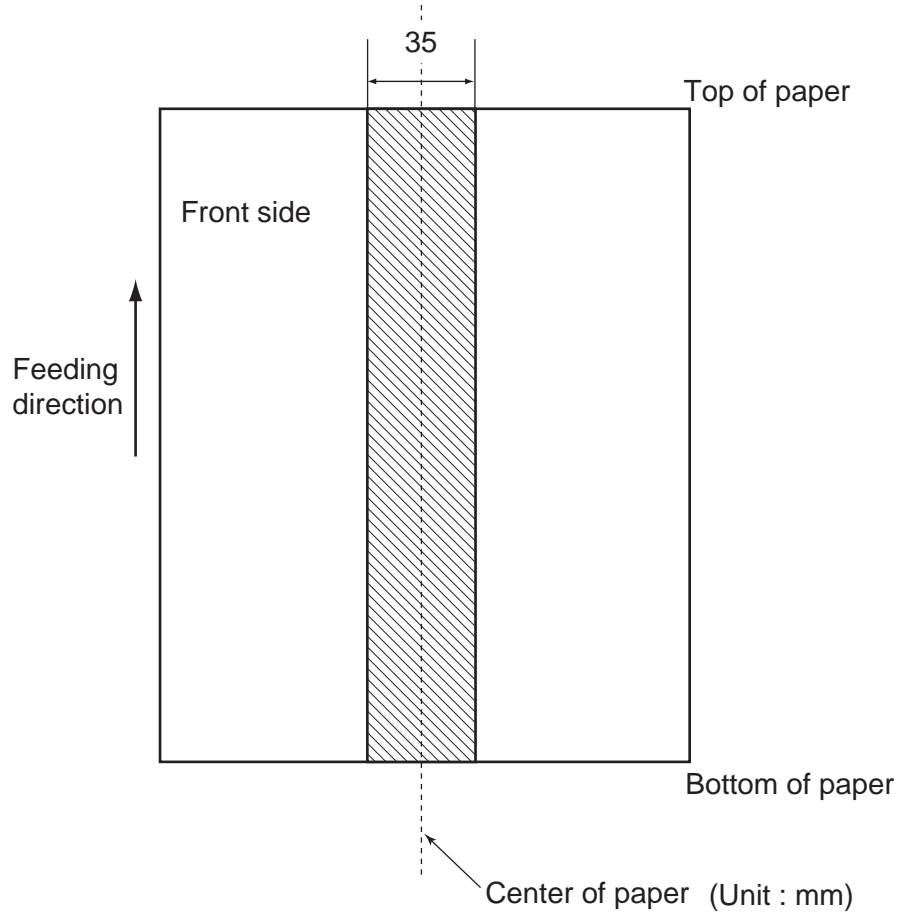



- When the overlapping check is specified, the papers which contact closely each other, such as glued paper or electro-statically charged paper, can result in the miss-detection of multifeed.
- Normally multifeed detection will monitor the following area of the document.

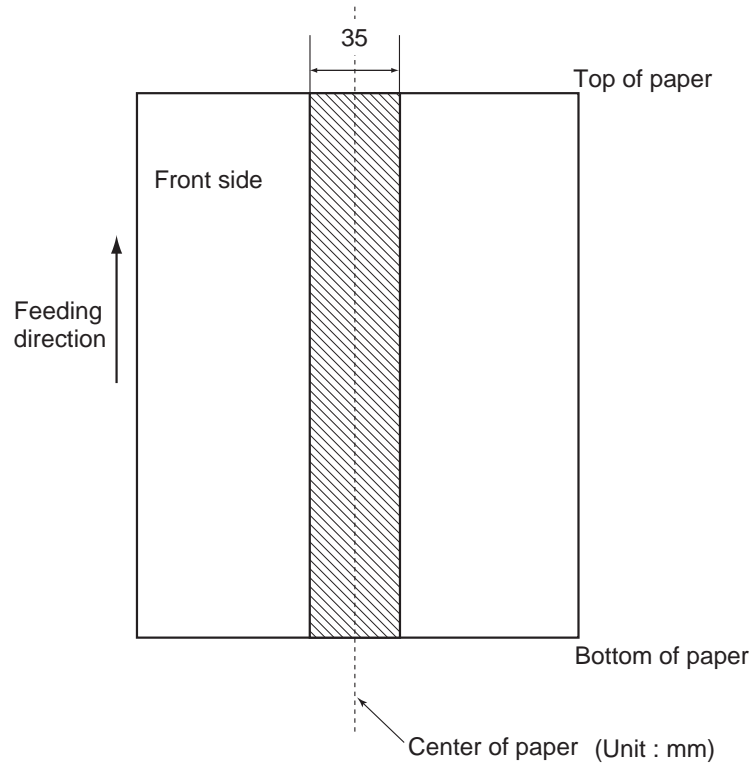

Chapter 7

SCANNER SPECIFICATIONS

This chapter lists the scanner specifications.

7.1 Basic Specifications	142
7.2 Installation Specifications.....	144
7.3 External Dimensions	145



7.1 Basic Specifications

No.	Item		Specification	
1	Scanner Type		ADF (Automatic Document Feeder)	-
2	Image sensor		CCD x 2	Front / Back
3	Light source		Incandescent cold cathode fluorescent lamp x 2	Front / Back
4	Scanning area	Minimum	A8 portrait	127 g/m ² paper
		Maximum	A3 / 11 x 17 in	
5	Paper Weight		52 to 127 g/m ² (13.9 to 34.0 lb)	(*1)
6	Scanning Speed (A4 Portrait) (*2)	Color Grayscale Binary (Black and White)	Simplex: 35 sheets/min. Duplex: 70 pages/min.	200 dpi
	Scanning Speed (A4 Landscape) (*2)	Color Grayscale Binary (Black and White)	Simplex: 50 sheets /min. Duplex: 100 pages/min.	200 dpi
7	Capacity of ADF (*3)		100 sheets	A4, 80 g/m ²
			50 sheets	A3 80 g/m ²
8	Optical Resolution		600 dpi	-
9	Output resolution	Binary (monochrome)	50 - 600, 1200 dpi	Scalable in 1 dpi increments 1200 dpi can be acheived by software processing(*4)
		Glayscale		
		Color		
10	Grayscale level		8 bits per color	Internal 10 bits
11	Halftone Patterns		Dither / Error diffusion	-

No.	Item	Specification	
12	Interface (*5)	Ultra SCSI	Shield-type 50 pin (pin-type) halfpich
		USB 2.0 / USB 1.1 (*6)	B Type
13	Other functions	JPEG compression	-
		Imprinter Port	-
14	Options	Imaging Processing Software	(*7)
		fi-553PR Imprinter	(*8)

- *1) For details, refer to ["6 DOCUMENT SPECIFICATIONS FOR ADF" on page 131](#).
- *2) The scanning speed shows the maximum performance of the scanner (hardware). Software processing time such as data transfer time is added to the actual scanning time. The scanning speed in color/grayscale mode shows the scanner performance when images already converted to JPEG are processed.
- *3) The maximum stacking capacity varies according to the document thickness. For details, refer to ["6 DOCUMENT SPECIFICATIONS FOR ADF" on page 131](#).
- *4) With a high resolution of 600dpi or more, scanning may be limited depending on the scan mode, the size of the document, and the memory size of the computer you are using.
- *5) The Ultra SCSI and USB2.0/1.1 interfaces cannot be used at the same time.
- *6) If you connect the scanner with USB 2.0, it its required that the USB port and the Hub are compliant with USB 2.0. The scanning speed may slow down when connecting with USB 1.1.
- *7) "Image Processing Software Option" is an optional software for FUJITSU fi-series scanners to perform advanced binarization processing using the "FUJITSU TWAIN 32" scanner driver.
- *8) By Using the Imprinter, a character string, such as the alphabet and numbers, can be printed in the scanned document. It helps you to organize your documents by printing a name, date, time or a serial number on the scanned document.

7.3 External Dimensions

The following shows the external dimensions of the fi-5530C2.

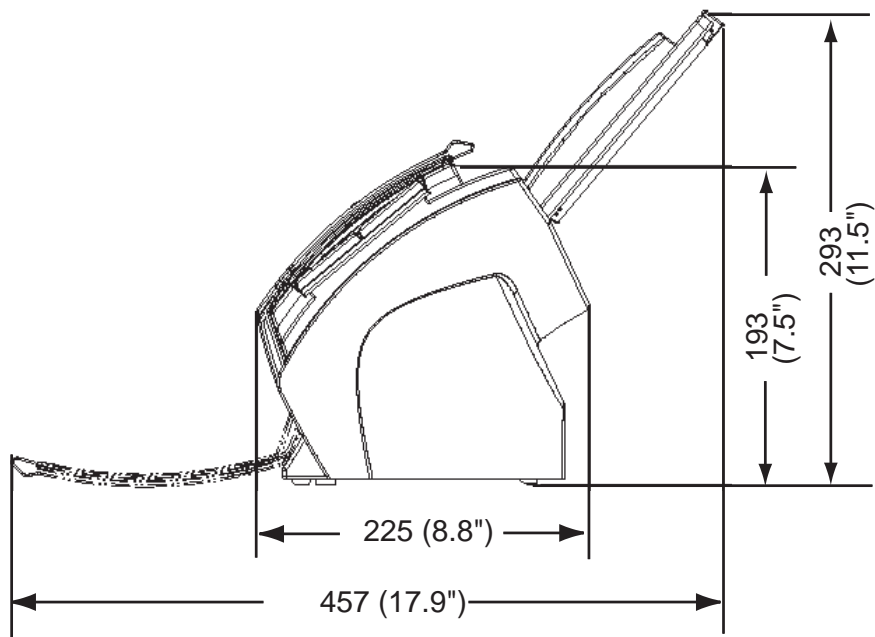
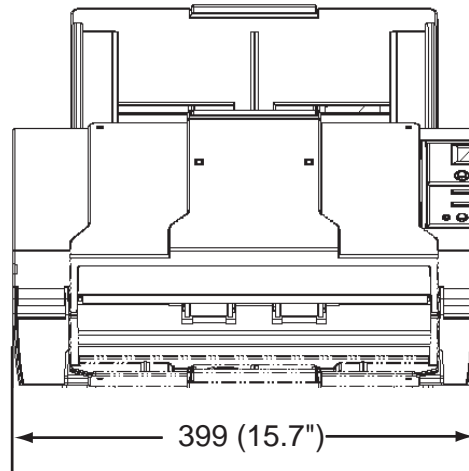

(Unit : mm)

APPENDIX A

Using the [Scan] or [Send to] Button

By linking software applications to the [Scan] or [Send to] button, you can launch the linked application at a press of a button.

(To use ScandAll PRO, read section 2.14 "Scanning by Pressing the Scan Button on the Scanner" on page 84.)

■ Settings to Configure on the Computer

1. Select [Start]-[Control Panel].
2. Select [Scanners and Cameras]-[Properties].
3. Display the [fi-5530C2dj Properties] dialog box.
In Windows XP or Windows Server 2003, right-click on the [fi-5530C2dj] icon, and then select [Properties]. In Windows 2000 or Windows Vista, double-click on the [fi-5530C2dj] icon.
4. Select the [Events] tab.
5. Select an event.
When the operating system you are using is Windows XP, select an event for starting up any application from the [Select an event] menu.

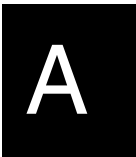
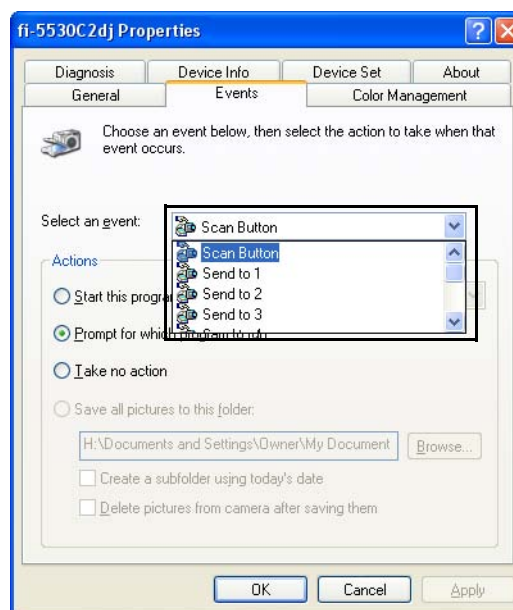

The events available for this function are:

- Scan Button (Press the [Scan] button)
- Send to 1-9 (With a number from 1 to 9 displayed on the Function Number Display, press the [Send to] button)

6. Select an application to be launched when an event occurs. If the operating system you are using is Windows XP, select [Start this program] under [Actions], and then select the application from the drop-down list.

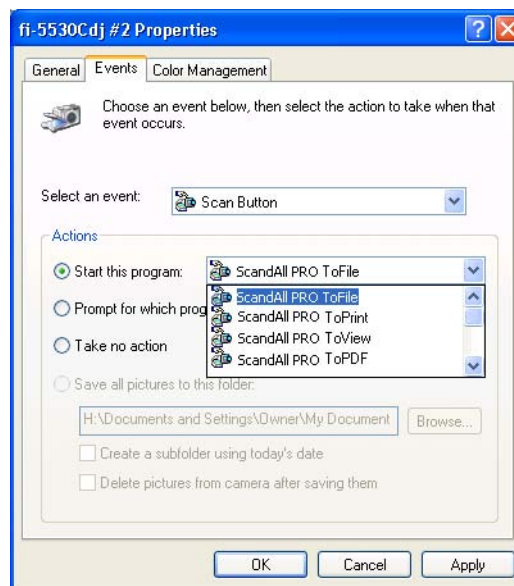

7. Click the [OK] button.



The screens and operations may vary depending on the operating system you are using.

■ Settings to Configure on the Scanner

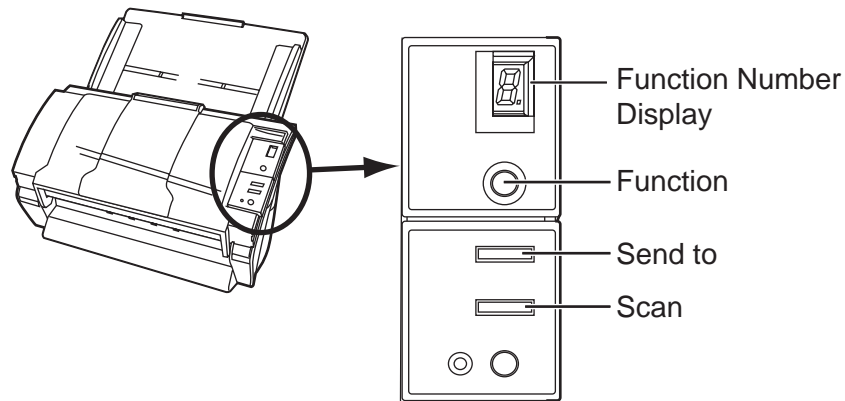

- When you want to use the [Scan] button
There is no specific settings.
⇒ Upon pressing the [Scan] button, the linked application starts up.
- When you want to use the [Send to] button
Press the [Function] button repeatedly to change a number displayed on the Function Number Display until the number matches the event number (from 1 to 9) you have set.
⇒ Upon pressing the [Send to] button, the linked application starts up.



- For example, when you want to execute the [Send to 2] event, change the number on the Function Number Display to "2".
- Every time you press the [Function] button, the displayed number changes as follows:
1, 2, 3,...9, C, 1, 2, 3... etc.

APPENDIX B

GLOSSARY OF TERMS

A4 size

A standard paper size. Paper size is 210 x 297 mm.

A5 size

A standard paper size. Paper size is 148 x 210 mm.

A6 size

A standard paper size. Paper size is 105 x 148 mm.

A7 size

A standard paper size. Paper size is 74 x 105 mm.

A8 size

A standard paper size. Paper size is 53 x 74 mm.

ADF (Automatic Document Feeder)

A unit that allows the user to scan a number of pages consecutively. Fed documents are transported from the ADF paper chute (or hopper) to the Stacker. Actual scanning operation is executed by the mechanism inside of this unit. Backside reading = Backside scanning Refers to reading the backside of the document, specifically in Duplex reading mode.

Automatic separation

An image processing method in which the scanner automatically detects difference between text and photos, and chooses the threshold accordingly. This function allows the scanner to switch between line mode and half tone mode in one pass.

Automatic size/skew detection

A function that automatically detects the document' page size and adjusts output data to the detected page size. Document skewing is automatically detected and corrected for the output image.

Brake roller

A roller that prevents two or more sheets of paper from being fed simultaneously into the ADF.

Brightness

Refers to the brightness of scanned images in this manual.

Canadian DOC Regulations

"A standard issued by Industry Canada, a department of the Canadian government, which sets out the technical requirements relative to the radiated and conducted radio noise emissions from digital apparatus. "

CCD (Charged Coupling Device) Image Sensor

A semiconductor device inside the scanner that registers light reflected from the original image and converts it into a digitized (electronic) form. CCD technology is the basis of high-quality image acquisition in scanners, cameras, and other specialized devices.

Cleaning paper

Sheets used with the F1 cleaner for cleaning the rollers (pick rollers, feed rollers, etc.) and complete document path in the scanner. Used in daily maintenance of the low volume production scanner to reduce paper transport problems. Note: these sheets are not meant to replace the more thorough periodic cleaning of the scanner.

Cleaning sheet

Adhesive sheets used for cleaning the rollers (pick rollers, feed rollers, etc.) and complete document path in the scanner. Used in daily maintenance of the high volume production level scanner to reduce paper transport problems. Note: these sheets are not meant to replace the more thorough periodic cleaning of the scanner.

Color balance

Balance of colors in images.

B

Default settings

Pre-set values for optional menus.

Density

In this manual, refers to a measurement of the depth of the display.

Dither

The process by which a group of dots is arranged to represent a shade of gray. The predetermined dot pattern simulates shades of gray. This scanning process offers the advantage of reduce memory requirements compared to multilevel gray.

Document jam

A warning that appears when document is jammed in the transport unit, or transportation is Interrupted because the paper is slipping.

dpi

Dots per inch. Number of dots lined along one inch A measurement of resolution normally used for scanners and printers. Higher dpi means better resolution.

Driver software

In this manual, driver software refers to software that allows the scanning application software to communicate with the scanner.

Dropout color

A color which is used in the document but does not appear in the read image.

Duplex reading mode

A mode for scanning both sides of the document in one pass.

Eject rollers

Rollers that transport documents from the ADF onto the Stacker.

Energy Star

ENERGY STAR is an international standard for energy-efficient electronic equipment. It was created by the US Environment Protection Agency (EPA) in 1992. The standard program has now been adopted by several countries around the world.

Equipment Error

An error that cannot be fixed by the operator. The operator should call the manufacturer for service.

Error diffusion

High-quality halftone (pseudo-grayscale) image production based on black-and-white pixel binarization. A pixel's optical density and that of adjacent pixels are summed, with black pixels relocated in their order of density as they relate to adjacent pixels. The purpose of this technique is to minimize the average error between read and printed densities. Density data for adjacent pixels is modified by diffusing errors on the objective pixel into several pixels, which are then binarized. This maintains high grayscale levels and resolution during reading, while suppressing more patterns by dotted halftone images such as newspaper photographs.

FCC

Acronym for "The Federal Communications Commission", an independent United States government agency which is in charge of regulating interstate and international communications via radio, television, wire, satellite and cable. The Part 15 of the FCC regulations mentioned in this manual is designed to prevent harmful interferences on radio communication of radio receivers and other devices which radiate radio frequency energy, and provides for the certification of radio receivers. It also provides the certification of low power transmitters and the operation of certificated transmitters without a license.

Feeds rollers

Rollers that feed documents through the ADF.

Filtering

A correction method that improves the read quality of handwritten documents. The read quality of images written in pencil or ball-pointed pen depends on the reflective light characteristics of the specific ink or lead used. Dropped pixels may produce outlines, gaps, or thin, barely connected lines due to uneven optical density. Filtering detects areas lighter than their surroundings and increases their density to improve image clarity.

Flat bed An input device of the scanner, where documents are placed and scanned. Generally used for scanning pages out of a book, or paper that is out of the feeding specification of the ADF. Also used to scan a small volume of documents by manual operation.

Flatbed

An input device of the scanner, where documents are placed and scanned. Generally used for scanning pages out of a book, or paper that is out of the feeding specification of the ADF. Also used to scan a small volume of documents by manual operation.

Gamma

A unit of changes of images' brightness. It is expressed as a function of the electric input power to devices (scanner, display, etc.) and an image's brightness. If the gamma rate is larger than 1, the brightness of an image increases and vice versa. In order to adjust the brightness of an image close to the original, generally the gamma value is set to 1.

Grayscale

A method for realizing the gradation from black to white on the scanned image. For example, when scanning monochrome documents, the computer recognizes the document as sets of black and white dots. In the Gray scale method, each dot contains data regarding density of black. The original gradation of the document is realized as the gradation of the density data.

Halftone processing

Any method used to reproduce a photograph which includes a shade as an image composed of dots, namely, a binary image. Dithering and error diffusion processing are examples of halftone processing.

Image emphasis

Density is decreased for lighter but not completely white areas adjacent to black areas. Weakening this emphasis eliminates spot noise or produces softened images.

Image processing

An image is scanned with specified parameters.

Interface

The connection that allows communication from the computer to the scanner.

Inversion (Reverse-image reading)

In reverse-image reading, data is changed from black to white and vice versa.

IPC preset mode

While reading binary images, it is necessary to set the scanner according to the quality of the sheet to be read. In this mode, these settings can be performed in advance by corresponding each setting to a pattern number.

ISIS (Image Scanner Interface Specification)

A standard of API (Application Program Interface) or protocol for imaging devices (scanners, digital cameras, etc.) developed by Pixel Translations, a division of Captive Software. In order to use imaging devices designed on the ISIS standard, it is necessary to install the driver software of the same standard.

Jaggy images

Images that have sharp projections or irregular shape on their edges.

Job separation sheet

A sheet inserted between documents in a batch for separating different jobs.

Landscape

A document is transported and read with the Short side parallel to the moving direction.

Landscape orientation

A document is transported and scanned with the long side vertical to the moving direction.

Letter size

A standard paper size used in the U.S.A. and other countries. Paper size is 8-1/2 x 11 inches.

Linedrawing mode

Selecting linedrawing mode makes threshold and contrast settings effective but prevents brightness from being set. The specified threshold value determines whether black or white pixels are scanned. Line drawing mode is therefore appropriate for scanning text and line art images.

Multifeed detection

A scanner function which detects accidental feeding of multiple sheets into the ADF. This can be set as both enabled/disabled.

Mirror image

The read image is symmetrically flipped to produce a mirror image of the original detected in the main scanning direction.

Moire Patterns

Recurrent patterns on scanned images caused by incorrect settings of angles.

Noise removal

Isolated noise from an image appearing as black spots in white areas and voids in black areas is removed to improve image quality.

Removes particles from the document image. Common particles include toner and fax particles. Noise reduction works via an algorithm that removes pixels up to 5 x 5 dots apart. A dot is 1/400 inch. A particle can be distinguished from a character as it is not connected to another dot within 5 pixels.

OCR (optical character recognition)

Devices or technologies for identifying characters on documents and converting them into text data that can be manipulated. The documents are checked by light and the differences of light reflection are recognized as character shapes.

Operator panel

A panel consists of indicators and buttons. The operator panel is used to control scanner operations such as, selecting features, and changing settings.

Optical sensor

A type of sensor for detecting Multifeeding by light transmission. It also detects multifeeding by recognizing differences in length of documents.

Outline extraction

The boundary between black and white areas is traced and the outline extracted for closed areas.

Pad ASSY (Pad Assembly)

This part is used to separate a sheet of paper from a batch before feeding documents into the ADF. This assembly is made out of rubber.

Photograph mode (White level follower OFF)

Selecting photograph mode makes brightness and contrast settings effective but prevents the threshold from being set. With photograph mode, the darkness of image corresponds to the black-pixel density, making it suitable in scanning images such as photographs having gradations.

Pick roller

Roller(s) that picks the page from the batch of paper in the paper chute and feed it into the ADF.

Pick start time

The period from the manual insertion of the document until picking starts after the document passes the hopper empty sensor.

Pixel (Picture Element)

The tiny dots that make up a scanned image.

Portrait

Orientation of documents or images. Documents/images are set or displayed vertically.

Portrait orientation

A document is transported and read with the long side parallel to the moving direction.

Resolution

The measure of the details or grain of images displayed on a computer screen. As a metric of the resolution, dpi is customarily used.

SCSI (Small Computer System Interface)

An abbreviation for "Small Computer System Interface". SCSI is a standard for interfaces, used to connect devices such as hard disks, scanners, etc. Up to seven devices can be connected through this interface (daisy chain). The data transfer rates are different between "Fast SCSI" (Max. 10MB/sec.) and "Wide SCSI" (Max. 20MB/sec.).

SCSI-ID

Used to specify a particular SCSI device when the initiator selects a target or the target reconnects to the initiator.

B

Separation roller

A roller that separates the sheets of paper from each other.

Simplex reading mode

A mode for scanning only the front side of the document.

Smoothing

A process that eliminates "jaggies" from slanted lines and curves. Irregular convexities are deleted and irregular concavities filled in. This is useful in OCR applications, for example.

Storage temperature/humidity

The temperature and humidity levels necessary for proper storage of the scanner.

Temporary Error

An error that can be fixed by the operator.

Terminator

Devices with a SCSI interface can be daisy-chained. A resistor that includes terminal circuits needs to be placed at both ends of the SCSI chain when devices are daisy-chained. If a device (such as a scanner) is the last device in a chain, leaving an interface connector unused, a Terminator therefore must be attached to provide those terminal circuits.

Third Party Interface

Used to install optional board provided by FUJITSU or interface board manufactured by a third party.

Threshold

A value used as a metric for judging a color as black or white. For scanning an image with gray gradation, this value must be defined. The threshold setting determines which pixels are converted to black and which will become white.

TUV

"An institution that controls products for conformity with various standards of security, usability and environmental matters. "

TWAIN (Technology Without Any Interesting Name)

A standard for API (Application Program Interface) or protocol for imaging devices (scanners, digital cameras, etc.) developed by TWAIN Working Group. In order to use devices that comply with this standard, it is necessary to install driver software based on the same standard.

Ultrasonic sensor

A type of sensor for detecting multifeeding by ultrasonic sound. Scanners detect multifeeding by recognizing differences in the amount of ultrasonic waves that penetrates the document.

USB (Universal Serial Bus)

An abbreviation for "Universal Serial Bus". A standard for interfaces used to connect devices such as key boards, scanners, etc. Up to 127 devices can be connected through this interface. USB devices can be plugged/unplugged without turning off their power. Data transfer rates are different between the "Low speed mode" (1.5Mbps) and "High speed mode" (Max. 12Mbps).

White level follower

A function to correct the difference between white colors in unbleached paper (e.g. wood containing paper, etc.) and in scanned images.

White Reference Stripe

The white part located in the ADF that defines the lightest area in an image, causing all other areas to be adjusted accordingly.



INDEX

B		FUJITSU TWAIN32 Scanner Driver 12
Batch Scan 37		
C		G
Checking Labels on the Scanner 130		Glass 93
Cleaning Materials 88		
Cleaner F1 88		
Color/Monochrome Auto Detection 77		H
Compression 54		Hole Punch Removal 81
Consumable and Replacement Cycle 96		How to use the Scanner Driver 12, 29
Correcting the skewed		
Documents 71, 74, 77, 79, 81, 84		
D		L
Detecting Multi Feeds 66		Loading Documents on the ADF for
Dimensions 145		Scanning 6
Document specifications 131		Locations for cleaning 91
Area not to be perforated 138		Eject roller 91
Document Quality 133		Feed roller 91
Document Size 132		Glasses 91
		Pad ASSY 91
		Pick roller 91
		Plastic roller 91
		Sheet guide 91
		Ultra sonic sensor 91
E		M
Eject roller 93		Maximum ADF Capacity 137
Excluding a Color from the Image		Multi feed Detection Conditions 139
(dropout color) 62		Multi Image 74
Extension 8		
F		O
Feed roller 93		OCR 55
FUJITSU ISIS Scanner Driver 16		Open Password 56

P	
Pad ASSY	92, 96
Paper Thicknesss Switch	48
Paper weight	137
Pick roller	92, 96
Plastic roller	93
Power button	2
Power Save Mode	5
Profile Editor	38

R	
Remedying Common Troubles	114
Removing Jammed Documents	110
Replacing the Pad ASSY	99
Replacing the Pick Roller	102
Reset the pad counter	101
Reset the pick counter	108

S	
Saving scanned Images in PDF Format .	51
Saving scanned images in PDF format	
Using Adobe Acrobat	57
Using ScandAll PRO	53
Scan	33
Scanner spacifications	141
Capacity of ADF	142
Dimensions	144
Input power	144
Interface	143
Paper Weight	142
Scanning area	142
Scanning Speed	142
Weight	144
Scanning Documents	10
Scanning Documents longer than A3 size	49

Scanning Documents with different	
Widths	47
Scanning double sided Documents	46
Scanning thin Documents	48
Searchable PDF	55
Security	55
Sheet guide	93
Side guide	9
Skipping blank Pages	64
Split Image	79
Standard Cleaning Cycle	88

T	
Troubleshooting	109
Turning the Scanner ON	2

U	
Ultra sonic sensor	93
Using the (Scan) or (Send to) button	1

fi-5530C2 Image Scanner Operator's Guide

P3PC-1922-01ENZ0

Issue Date: June, 2007
Issued by: PFU LIMITED

-
- The contents of this manual are subject to change without notice.
 - PFU LIMITED is not liable whatsoever for any damages resulting from the use of this scanner and procedures described in this manual, profit loss due to defects, and any claims by a third party.
 - Copying of the contents of this manual in whole or in part and copying of the scanner application is prohibited under the copyright law.